

# NSW DRIED BLOOD SPOT HIV AND HEPATITIS C TESTING PILOT

## MID-POINT EVALUATION

NOVEMBER 2016 – DECEMBER 2020



## NSW Dried Blood Spot HIV and Hepatitis C Testing Pilot: Mid-Point Evaluation, November 2016 – December 2020

Authors: Anna Conway<sup>1,2</sup>, Nigel Carrington<sup>3,4</sup>, Annabelle Stevens<sup>4</sup>, Jason Grebely<sup>1</sup>, Sophy Shih<sup>1</sup>, Heng Lu<sup>3</sup>, Mitchell Starr<sup>5,6</sup>, Beth Catlett<sup>1,5,6</sup>, Bianca Prain<sup>4</sup>, Joanne Holden<sup>7</sup>, Colette McGrath<sup>7</sup>, Phillip Read<sup>8</sup>, Melanie Kingsland<sup>9,10,11</sup>, Phillip Keen<sup>1</sup>, Louise Causer<sup>1</sup>, Rebecca Guy<sup>1</sup>, Cherie Power<sup>4</sup>, Carolyn Murray<sup>4</sup>, Anna McNulty<sup>3</sup>, and Philip Cunningham<sup>5,6</sup>

<sup>1</sup>The Kirby Institute, UNSW

<sup>2</sup>Centre for Social Research in Health, UNSW

<sup>3</sup>Sydney Sexual Health Centre – South Eastern Sydney Health District

<sup>4</sup>Centre for Population Health, NSW Ministry of Health

<sup>5</sup>NSW State Reference Laboratory for HIV, St Vincent's Hospital

<sup>6</sup>St Vincent's Centre for Applied Medical Research, St Vincent's Hospital

<sup>7</sup>NSW Justice Health & Forensic Mental Health Network

<sup>8</sup>Kirketon Road Centre, South Eastern Sydney Local Health District

<sup>9</sup>School of Medicine and Public Health, The University of Newcastle

<sup>10</sup>Population Health Research Program, Hunter Medical Research Institute

<sup>11</sup>Hunter New England Population Health, Hunter New England Local Health District

Suggested citation: Conway A, Carrington N, Stevens A, Grebely J, Shih S, Lu H, Starr M, Catlett B, Prain B, Holden J, McGrath C, Read P, Kingsland M, Keen P, Causer L, Guy R, Power C, Murray C, McNulty A, and Cunningham P. (2023). NSW Dried Blood Spot HIV and Hepatitis C Testing Pilot: Mid-Point Evaluation, November 2016 – December 2020. NSW Health: Sydney, Australia

# ACKNOWLEDGEMENTS

## The NSW dried blood spot HIV and hepatitis C testing pilot program operates on Aboriginal lands.

We would like to acknowledge the NSW DBS Pilot team who reviewed the report before publication:

Anna McNulty (Sydney Sexual Health Centre – South Eastern Sydney Health District), Nigel Carrington (Sydney Sexual Health Centre – South Eastern Sydney Health District; Centre for Population Health, NSW Ministry of Health), Heng Lu (Sydney Sexual Health Centre – South Eastern Sydney Health District), Annabelle Stevens (Centre for Population Health, NSW Ministry of Health), Bianca Prain (Centre for Population Health, NSW Ministry of Health), Carolyn Murray (Centre for Population Health, NSW Ministry of Health), Danielle Campbell (Centre for Epidemiology and Evidence, NSW Ministry of Health), Frances Turner (Sydney Sexual Health Centre – South Eastern Sydney Health District), Cherie Power (Centre for Population Health, NSW Ministry of Health), Kate Patten (Centre for Population Health, NSW Ministry of Health), Andrew Milat (Evidence and Evaluation, NSW Ministry of Health), Marian Bloomfield (NSW Justice Health & Forensic Mental Health Network), Joanne Holden (Centre for Population Health, NSW Ministry of Health; NSW Justice Health and Forensic Mental Health Network), Colette McGrath (NSW Justice Health & Forensic Mental Health Network), Phillip Read (Kirketon Road Centre, South Eastern Sydney Local Health District), Mitchell Starr (NSW State Reference Laboratory for HIV, St Vincent's Hospital; St Vincent's Centre for Applied Medical Research, St Vincent's Hospital), Philip Cunningham (NSW State Reference Laboratory for HIV, St Vincent's Hospital; St Vincent's Centre for Applied Medical Research, St Vincent's Hospital), Beth Catlett (The Kirby Institute, UNSW Sydney; NSW State Reference Laboratory for HIV, St Vincent's Hospital; St Vincent's Centre for Applied Medical Research, St Vincent's Hospital), Jason Grebely (The Kirby Institute, UNSW), Rebecca Guy (The Kirby Institute, UNSW), Phillip Keen (The Kirby Institute, UNSW), Louise Causer (The Kirby Institute, UNSW).

# THANK YOU

## The NSW DBS Pilot has been a collaboration between a large number of agencies and individuals. We wish to thank them sincerely for their contribution to this important piece of research.

The NSW DBS Pilot was made possible through a partnership between the following key agencies/services:

- i. The NSW Ministry of Health which sponsors the study, provides funding, strategic planning and policy framework, and leadership in the establishment and maintenance of the study.
- ii. The NSW HIV State Reference Laboratory at St Vincent's Hospital, Sydney which provides pathology services, kit supplies and scientific expertise.
- iii. The NSW Sexual Health Infolink service which collects and manages all the testing and results data, provide results and clinical expertise and advice to participants and site staff.
- iv. The Sydney Sexual Health Centre – South Eastern Sydney Health District which provides clinical governance and project coordination including training and support of study sites.
- v. The Kirby Institute, UNSW which provides research and evaluation expertise.

We would like to thank all the staff at sites who participated in the delivery of the study, particularly the principal investigators: Alexandra Wade (Lismore Liver Clinic), Alison Nikitas (Murrumbidgee HARP Unit, Southern NSW LHD HARP Unit) Annie Malcolm (Drug Health Services), Dr Catriona Ooi (The Beaches Clinic), Dr Craig Rodgers (Rankin Court Treatment Centre), Dr David Smith (Lismore Sexual Health Service), Dr Eva Jackson (NBM south Court Primary Care (NSP)), Dr Katherine Brown (ISHDACS), Dr Mark Montebello (NSLHD Drug and Alcohol Service), Dr Phillip Read (Kirketon Road Centre), Dr Tony Gill (Southern NSW LHD Drug and Alcohol Service), Dr Winston Kardell (NBM DACS/OTP), Gary Keogh (Drug Health Services), Jo Lenton (Far Western Primary Health Care), Karen Gilham (HNE DACS (Northern)), Sarah Smith (iCHAT community hepatitis service), Carolyn Stubley (WHOS (We Help Ourselves)), Dr James Blogg (Sydney Drug Health Service), Dr Miriam Levy (South Western Sydney Gastro and Liver Service), Dr Thao Lam (Western Sydney Drug Health Service), Karl Johnson (ACON Health Ltd), Kim Grant (Western NSW HARP), Marian Bloomfield CNC (Justice Health & Forensic Mental Health Network), Phinn Borg (The Gender Centre), Sandhya Goundar (Liverpool Sexual Health), Shih Chi Kao (Sydney LHD HARP Unit), Sinead Sheils (Gastro and Liver (AW Morrow)).

Finally, we wish to thank everyone who agreed to participate in the pilot.



# CONTENTS

EXECUTIVE SUMMARY .....	2
INTRODUCTION .....	6
OVERVIEW OF THE PILOT .....	8
EVALUATION METHODOLOGY .....	13
RESULTS .....	16
ONLINE SELF-REGISTRATION .....	16
ASSISTED REGISTRATION IN THE COMMUNITY .....	18
ASSISTED REGISTRATION IN PRISON .....	20
MEN WHO HAVE SEX WITH MEN .....	22
ABORIGINAL AND TORRES STRAIT ISLANDER PEOPLE .....	24
1. REACH .....	26
2. EFFECTIVENESS .....	32
3. ADOPTION .....	39
4. IMPLEMENTATION .....	41
5. MAINTENANCE .....	51
CONCLUSION .....	53
REFERENCES .....	55
ANNEX 1 Outcome Definitions .....	56
ANNEX 2 General Considerations For Data Analyses .....	57
ANNEX 3 Supplementary Analyses .....	60
ANNEX 4 Health Economics Analysis Methodology .....	73

# EXECUTIVE SUMMARY

## NSW Dried Blood Spot HIV and hepatitis C testing pilot: An essential person-centred strategy to improve access to HIV and hepatitis C testing

### WHAT IS THE PROBLEM?

Despite Australia's ongoing efforts, there is a long way to go to eliminate hepatitis C and HIV transmission:







- **130,000** people are living with hepatitis C infection
- **2,610** people were living with undiagnosed HIV infection in 2020
- Australia needs to increase targeted testing to achieve the 2030 goals of the World Health Organization to eliminate hepatitis C and HIV transmission
- Testing barriers include stigma and discrimination, limited access to services, off-site pathology, language, and culture



### WHAT IS THE SOLUTION?

With testing and treatment both decreasing, we urgently need testing models that are flexible and person-centred. Dried blood spot (DBS) testing is a safe, private, and confidential strategy.







Key elements of the DBS testing strategy

	Simple finger prick blood sample		Results delivered via phone or in person
	Sample collection (DBS) done at home (online self-registration via <a href="http://dbstest.health.nsw.gov.au">dbstest.health.nsw.gov.au</a> ) or via health services		Reduces the number of clinic visits required for a diagnosis, improving linkage to care and treatment
	HIV and/or hepatitis C testing performed on DBS sample at reference laboratory		DBS testing is useful in prisons as it can be used to test large populations quickly, with limited clinical space





## NSW DBS PILOT EVALUATION - ASSESSING THE FEASIBILITY OF DBS HIV AND HCV TESTING

The evaluation uses the RE-AIM framework to assess the Reach, Effectiveness, Adoption, Implementation, and Maintenance of the NSW DBS Pilot

### KEY OUTCOMES OF THE NSW DBS PILOT (NOV 2016 – DEC 2020)

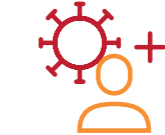
	<b>10,000+</b> registrations for a DBS test		<b>64%</b> of those who registered online returned a sample to the lab for testing
	<b>8,696</b> tests completed		<b>29%</b> of people tested were Aboriginal and/or Torres Strait Islander
	<b>7,392</b> unique people tested		<b>74%</b> tested for both HIV and hepatitis C
	<b>TAKE HOME KITS</b> DBS home sample collection offered a viable testing alternative during COVID-19 lockdowns		

### HEPATITIS C & HIV KEY OUTCOMES

	<b>TESTS PERFORMED</b> <b>6,573</b> Hepatitis C <b>8,600</b> HIV		<b>878</b> active hepatitis C infections <b>10</b> new HIV infections
	<b>UNIQUE PEOPLE TESTED</b> <b>5,960</b> Hepatitis C <b>6,922</b> HIV		<b>45%</b> of people diagnosed with hepatitis C initiated treatment within six months
	<b>PERCENTAGE OF PEOPLE TESTED WHO HAD NOT TESTED IN THE TWO YEARS PRIOR TO REGISTRATION</b> <b>45%</b> Hepatitis C <b>51%</b> HIV		<b>61%</b> of people in prison diagnosed with hepatitis C initiated treatment within six months

## TESTING OVER TIME

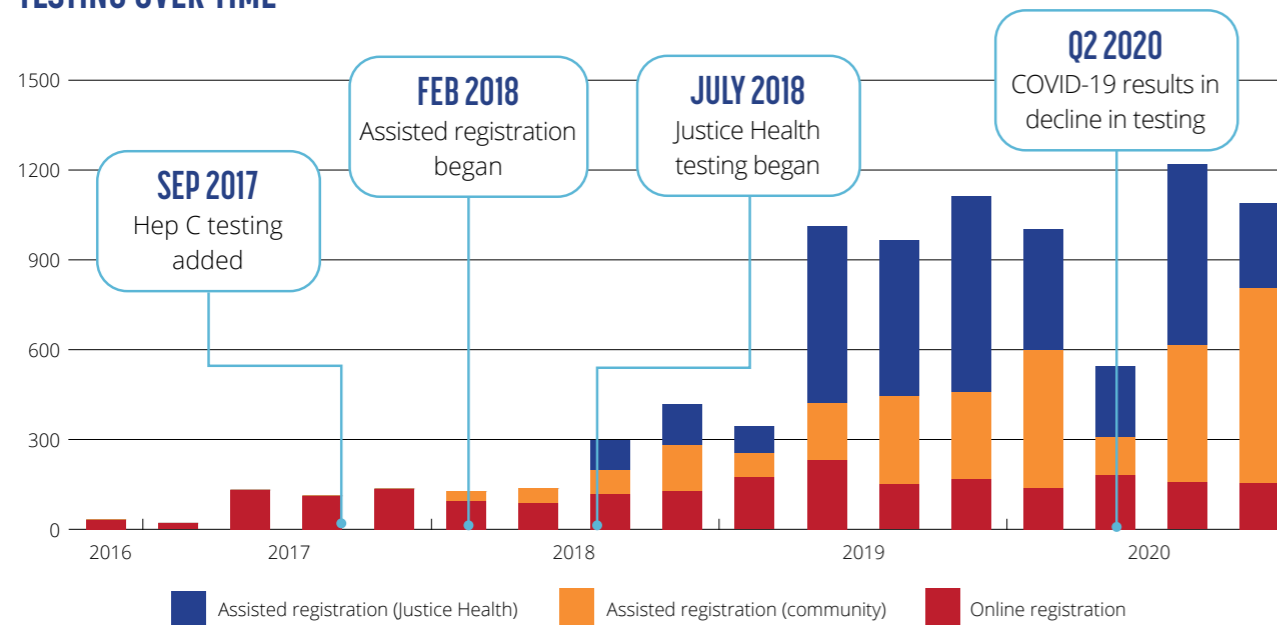

## HEALTH ECONOMICS ANALYSIS

Based on equal distribution of the shared costs of HIV and hepatitis C tests, costs were:

- The average direct testing cost per test completed was \$37 for HIV and \$97 for hepatitis C.

For HIV (considering operational costs i.e., direct testing costs and indirect fixed costs)

- The average cost per new diagnosis was \$52,000 - \$65,000 (\$31,000 for people diagnosed via online self-registration and \$214,000 for people diagnosed via assisted registration in prison)
- The average cost per treatment initiation was \$59,000 - \$74,000 (\$35,000 for people diagnosed via online self-registration and \$214,000 for people diagnosed via assisted registration in prison)

For hepatitis C (considering operational costs i.e., direct testing costs and indirect fixed costs)

- The average cost per diagnosis was \$1,000-\$1,100 (\$769 for people diagnosed via assisted registration in the community and \$1,029 for people diagnosed via assisted registration in prison)
- The average cost per treatment initiation was \$2,300-\$2,600 (\$2,845 for people diagnosed via assisted registration in the community and \$1,700 for people diagnosed via assisted registration in prison)

## KEY OUTCOMES

- The NSW DBS Pilot improved the reach of HIV and hepatitis C testing for a range of priority populations and people who had not recently received testing
- Overall, ten new HIV diagnoses were detected: nine via online self-registration and one via assisted registration in prison. No new HIV diagnoses were detected via assisted registration in community settings
- There was low uptake of hepatitis C DBS testing via the online self-registration pathway, but in this arm of the study, the proportion of people with current hepatitis C infection among people who recently injected drugs was comparable to other settings
- Prison settings accounted for a high proportion of hepatitis C DBS tests in the Pilot and reported high treatment uptake
- Treatment uptake for hepatitis C testing in the community is lower than in prison but comparable with standard of care and demonstrates success in expanding the reach of testing for priority populations
- There are disparities in hepatitis C treatment uptake across settings
- The results of this evaluation should be used to identify efficiencies and inform targeted testing for the remaining years of the DBS Pilot

## IMPLICATIONS FOR PRACTICE

- DBS testing via assisted registration for hepatitis C infection in prisons and community settings should continue to be offered
- Hepatitis C DBS testing in prison could be scaled up with additional resources to support more frequent testing "blitzes" and expanded to private prisons
- DBS testing for HIV infection via the online self-registration pathway should continue to be offered to priority populations at increased risk of HIV infection given its ability to reach significant numbers of people who have not tested recently
- DBS testing for hepatitis C infection via the online self-registration pathway shows promise and the low uptake so far in the pilot could be improved with promotional strategies to reach people who inject drugs who may not access other services
- Where DBS testing is offered in community or prison settings, HIV testing should only be considered if specific HIV risk factors are identified
- The success in reaching priority populations in community settings could be enhanced by ongoing promotion of the DBS Pilot through targeted health promotion activities and communication strategies tailored to specific populations
- In-depth interviews with service providers could provide important insights into barriers and facilitators to enhance DBS testing

# INTRODUCTION

## ELIMINATING HIV TRANSMISSION AND HEPATITIS C IN NSW

Advances in treatment options mean that treating HIV and hepatitis C is easier than ever before. Direct Acting Antivirals (DAAs) have a 95% cure rate for hepatitis C (1) and the availability of antiretroviral therapy means that people diagnosed with HIV can live a long and healthy life (2).

***But to do so, people must be tested and treated as early as possible.***

While this may sound simple, there are many barriers to accessing testing and treatment – with stigma and discrimination at the heart of these challenges (3,4).

Dried blood spot (DBS) is a self-collection method that enables people to collect samples in their own home or other safe place, post back the sample for testing at an accredited laboratory and receive results without having to necessarily attend a health service. This may improve convenience for participants and increase uptake and frequency of HIV and hepatitis C testing for high priority populations (5).

DBS testing offers advantages when compared to conventional venous blood samples, particularly in relation to logistics such as the transportation of samples to central testing laboratories and in settings where laboratory infrastructure may be limited. Additionally, as a blood (rather than oral fluid) sample is collected, acute infections are more likely to be detected.

The NSW dried blood spot (DBS) HIV and hepatitis C testing pilot (hereafter NSW DBS Pilot) was launched in November 2016 with the primary objective of increasing access to HIV testing for priority populations who infrequently test for HIV. DBS was made available for gay and other men who have sex with men, people born in high prevalence regions (for the purpose of this study, this includes Asia and Africa) and people with current or previous sexual partners from high prevalence regions. In September 2017, hepatitis C RNA testing was added to the pilot for individuals who identify as Aboriginal and/or Torres Strait Islander or people with a history of injecting drug use. As the pilot was initially developed as an HIV testing pilot, participants eligible for hepatitis C DBS testing had the option to opt to have a dual HIV and hepatitis C test or opt out of the hepatitis C and be tested for HIV only (i.e. all hepatitis C tests were also tested for HIV).

In the first year of the pilot, participants could register and order a DBS kit online, complete self-sampling at home and post back the sample to receive results via SMS, email or phone call. From September 2017, the 'assisted registration pathway' was introduced allowing participants to register for DBS at participating services and complete testing with assistance from a trained worker if required. Both pathways require individual registration online. Those being assisted have a sample taken with a kit sent to the service provider and those testing at home receive a kit in the post direct from the laboratory. Services that joined the pilot could deliver results to participants or continue to use the Sexual Health Info Link to deliver results. Participating services included Opioid Treatment Program clinics, Needle and Syringe Program services, Drug health services and other Alcohol and other Drug services. There was also the option for community-based services that had not signed up to the pilot to distribute kits to participants to complete at home or at community events. This has been used at a range of services and events such as the Broken Heel Festival, across some NSW pharmacies, BluesFest and included in the ACON 'How Hard' play kits.

## THE ROLE OF DRIED BLOOD SPOT TESTING

Australia needs convenient and acceptable models of care to ensure people living with, or at risk, of HIV and hepatitis C can access the testing and treatment they need. Dried Blood Spot (DBS) testing is a powerful option, offering the possibility for people to get tested without venepuncture and without visiting traditional healthcare settings.

For people living in rural areas or those who do not regularly attend services directed at key populations, DBS could be a lifesaver. Access to flexible testing options like DBS offers privacy, reduces the impact of stigma, and is integral to increasing testing and treatment uptake.

### HIV - WHERE WE'RE AT

**From 2015–2019:**

HIV diagnoses decreased by **19%** in NSW residents (6)

**25%** among men who have sex with men

NSW achieved

### **VIRTUAL ELIMINATION**

of HIV transmission between mother and child, among people who inject drugs, and among female sex workers

### HEPATITIS C - WHERE WE'RE AT

By end of 2020,

**43%** of people in NSW with chronic hepatitis C received treatment (7)

In 2020, around

**40,000** people were living with hepatitis C in NSW (7)

Direct-acting antiviral (DAA) therapies offer a

### **SAFE AND EFFICIENT**

way to cure hepatitis C





# OVERVIEW OF THE PILOT

The NSW DBS Pilot was launched to increase uptake of HIV and hepatitis C testing among key populations in NSW, by piloting the use of DBS testing as a flexible and accessible way to get tested and linked to treatment.

The pilot was initiated with the launch of a website ([dbstest.health.nsw.gov.au](http://dbstest.health.nsw.gov.au)) where people could easily request a DBS test for quick, at-home self-sampling. As the pilot progressed, assisted registration and DBS sample collection was also offered in 36 community health sites and 21 prisons across NSW.

## THERAPEUTIC GOODS ADMINISTRATION APPROVAL

There are currently no HIV or hepatitis C serological or molecular laboratory assays available within Australia that include DBS as a registered sample type as approved by the Therapeutic Goods Administration (TGA). Therefore, the NSW DBS Pilot was implemented as a research study under the TGA Clinical Trial Notification (CTN) Scheme.

The pilot required formal ethics approval by the Aboriginal Health and Medical Research Council Human Research Ethics Committee, NSW Corrective Services Ethics Committee and St Vincent's Hospital (Sydney) Human Research Ethics Committee, as well as Local Health District governance approval.

In Australia, DBS testing for HIV and hepatitis C is currently available only in NSW, under this pilot.

## KEY MILESTONES

The NSW DBS Pilot began in November 2016 and is ongoing. Data from the period November 2016 – December 2020 has been analysed for this report. The program evolved throughout the four years, launching with self-registration, then adding assisted registration at community sites and prisons.

Figure 1: Timeline of the NSW DBS Pilot November 2016 – December 2020

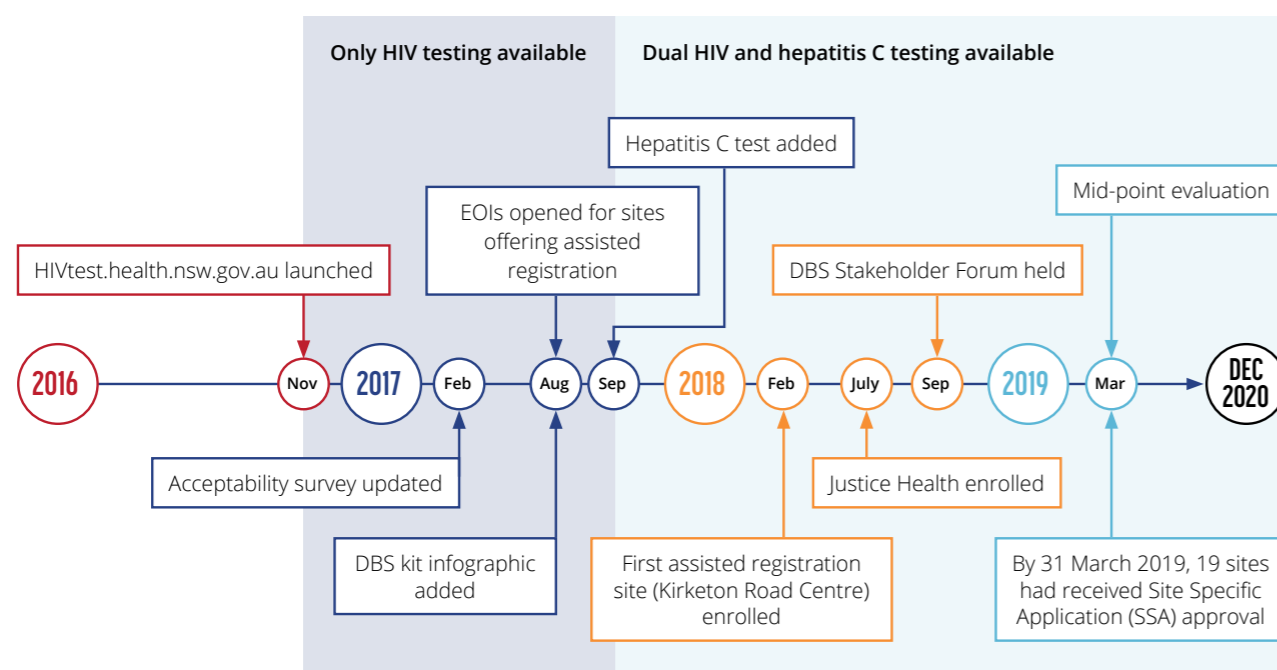

## ONLINE SELF-REGISTRATION

All results were provided via the Sexual Health Infolink service which has an established process for providing results of hepatitis C, HIV and other sexually transmitted infections to individuals, and linking the person to local care.

Figure 2: Registration and receipt of results for online registration pathway, NSW DBS Pilot

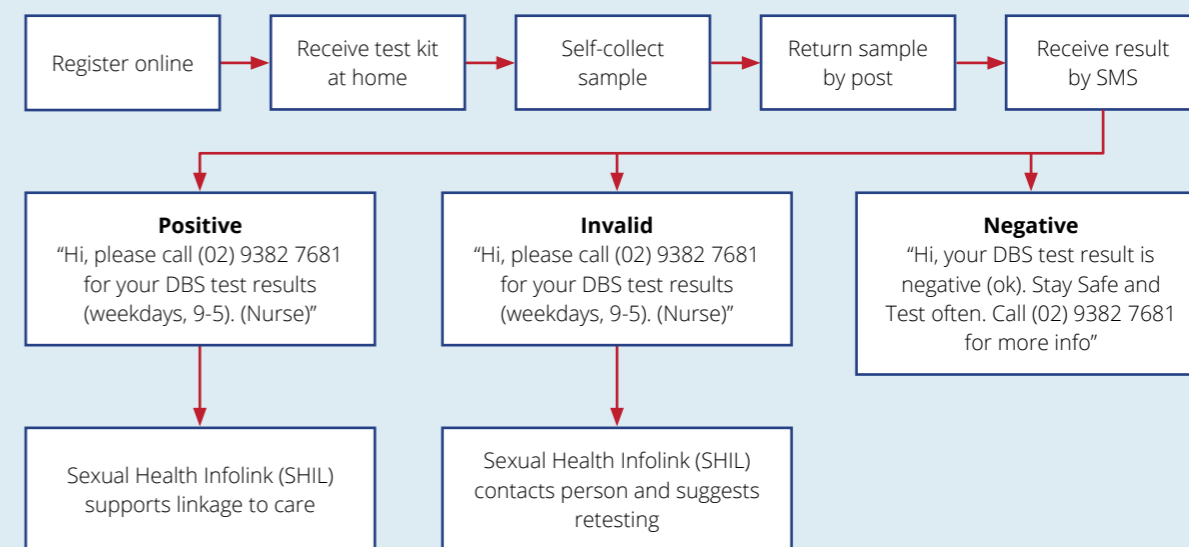

## MAKING IT EASIER

A plain language information sheet was available on the website. These were offered in Chinese (Traditional), Indonesian, Thai, Vietnamese, Arabic, Portuguese, French and Spanish.



## ASSISTED REGISTRATION

Figure 3: Registration and receipt of results for assisted registration pathway, NSW DBS Pilot

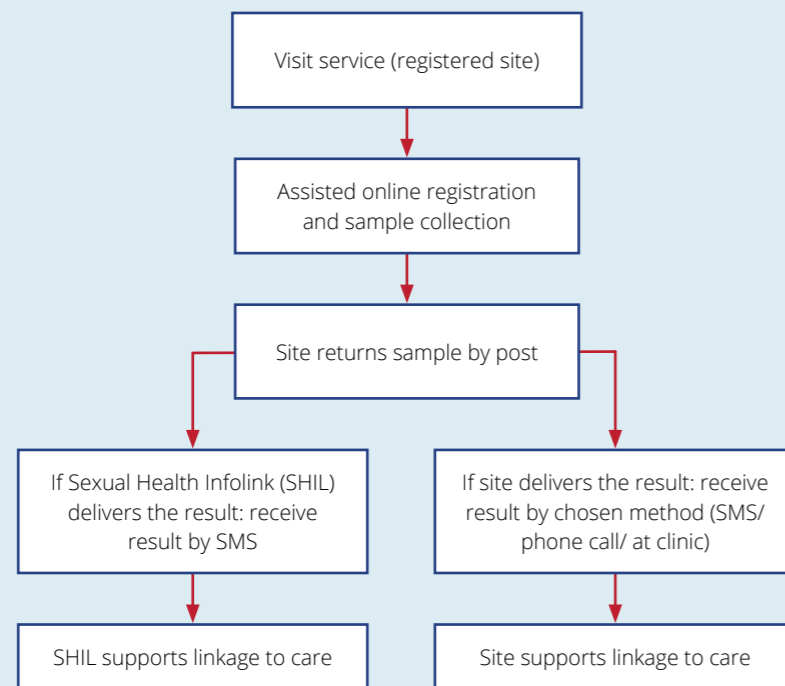

## DBS TESTING IN THE LABORATORY

Once a DBS sample was collected, it was mailed back to NSW State Reference Laboratory for HIV (St Vincent's Hospital, Sydney).

Depending on the request, the card was tested for HIV and/or hepatitis C. The algorithm for testing is based on current evidence on DBS testing (8, 9, 10) and is shown below (Figure 4). All non-negative results are followed up with confirmatory testing via venepuncture.

Figure 4: HIV and HCV DBS screening laboratory testing algorithm

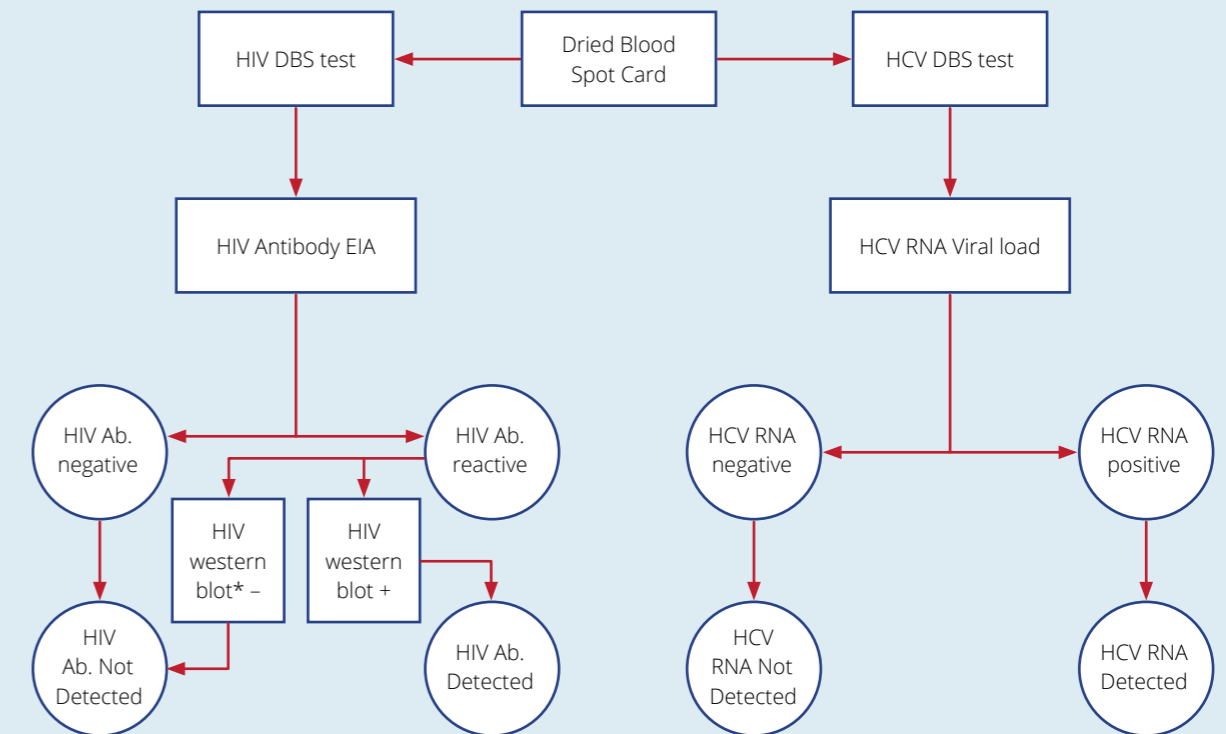

Assay detail:  
 HIV Ab/Ag EIA: Diasorin Murex HIV Ab/Ag ELISA  
 HIV Western Blot: Biorad HIV New LAV Blot II  
 (\* indeterminate blot requires conventional venepuncture)  
 HCV RNA viral load: Hologic Aptima HCV Quant Dx (1,2,3)



## PROJECT PARTNERS

The NSW DBS Pilot brings together a wide range of partners, each with a clear role in the implementation of the program and the overall, clinical, and pathology governance of the pilot.



### NSW MINISTRY OF HEALTH

- Primary funder and lead organisation
- Oversees implementation
- Monitoring and evaluation
- Commissioning evaluations
- Provide public health policy leadership and strategy



### SEXUAL HEALTH INFOLINK (under the clinical governance of Sydney Sexual Health Centre – South Eastern Sydney Health District)

- Delivers results to participants
- Automate text message delivery of negative results to home testing participants
- Refers home testing participants with positive results to appropriate local services
- Responsible for liaison and troubleshooting with sites
- Provides data capture and storage of results



### SYDNEY SEXUAL HEALTH CENTRE – SOUTH EASTERN SYDNEY HEALTH DISTRICT

- Provides coordination of the project including initiation, training and support of sites
- Provides overall clinical governance
- Coordinate project governance



### NSW STATE REFERENCE LABORATORY FOR HIV/AIDS AT ST VINCENT'S HOSPITAL SYDNEY

- Centralised point of DBS kit distribution and receipt
- Pathology testing and governance under the stewardship of the Chief Operating Officer of St Vincent's Centre for Applied Medical Research
- Provide scientific advice and expertise



### THE KIRBY INSTITUTE, UNSW

- Provides research and evaluation expertise
- Responsible for the evaluation of the pilot

# EVALUATION METHODOLOGY

The NSW DBS Pilot aimed to produce practical learnings that will assist in DBS being transitioned successfully into real-world settings.

The NSW DBS Pilot was assessed using the **RE-AIM** framework (11) which identifies factors that have led to implementation success - informing refinement of implementation strategies for program scale-up.

The framework consists of five different dimensions:

**R**each, **E**ffectiveness, **A**doption, **I**mplementation, **M**aintenance.

#### Primary objective

To assess the feasibility of using DBS to test for HIV and hepatitis C

#### Secondary objectives

##### 1 Reach

- How many DBS tests were performed?
- Who was tested?
- Who registered online and returned a sample?

##### 2 Effectiveness

- What was the HIV testing history of people tested?
- What was the hepatitis C testing history of people tested?
- Who was newly diagnosed with HIV?
- Who initiated treatment after being diagnosed with HIV?
- Who was diagnosed with hepatitis C?
- Who had a confirmatory test after being diagnosed with hepatitis C?
- Who initiated treatment after being diagnosed with hepatitis C?
- How acceptable was the pilot to people using online self-registration?

##### 3 Adoption

- How many sites now have capacity to perform DBS testing?

##### 4 Implementation

- Which sites returned DBS tests that were distributed to them?
- What proportion of returned DBS cards had sufficient sample?
- What was the time from kit delivery to receipt of result?
- What was the cost per test, diagnosis and treatment initiation for HIV and hepatitis C?

##### 5 Maintenance

- Who tested more than once in the pilot?
- How many sites are still participating?
- Number of sites which will participate
- What aspects of the pilot were modified during implementation?

## DATA SOURCES

The NSW DBS Pilot Evaluation draws on several data sources:

### SOCIODEMOGRAPHIC DATA

Upon registration, participants complete a survey of sociodemographic and behavioural data. Sexual Health Infolink is responsible for the data capture.

### HIV AND HEPATITIS C TEST RESULTS

NSW State Reference Laboratory for HIV/AIDS at St Vincent's Hospital Sydney is responsible for pathology testing, data capture of results, and data on kit distribution and return.

### TREATMENT UPTAKE

Sexual Health Infolink and all sites that offer assisted registration complete a standardised case report form which are collated to present data on treatment initiation following diagnosis. Collecting treatment outcome information was not always possible because of differing models of care and varying contexts of service delivery.

### ACCEPTABILITY MEASURES

The acceptability survey was launched in June 2017 was administered via Survey Monkey for people participating via online self-registration. Participants were prompted to complete the survey through text message reminders within 1 month of receiving a result from a DBS test.

### CASE STUDIES

The NSW DBS Pilot requested that the staff at Sexual Health InfoLink and several sites offering assisted registration submit case studies that illustrate the utility of DBS sampling and the challenges that were encountered during the pilot. These case studies are presented throughout the report. All names have been changed.



# RESULTS

## NSW DBS PILOT AT A GLANCE: ONLINE SELF-REGISTRATION

### REACH

- 3506** online registrations and 64% returned sample to the lab
- 1559** unique people tested
- 99%** tested for HIV
- 18%** tested for hepatitis C
- 65%** were men who have sex with men
- 87%** in postcodes moderately or sparsely populated with gay men<sup>12</sup>
- 45%** were born outside of Australia

### EFFECTIVENESS

- 60%** had not tested for HIV in the last two years
- 74%** had not tested for hepatitis C in the last two years
- 0.5%** people were diagnosed with HIV, 7 initiated treatment within 6 months
- 5%** were diagnosed with hepatitis C
- 13%** initiated hepatitis C treatment within six months
- High acceptability**
- 96%** of participants surveyed said the process was easy
- 91%** liked that the DBS pilot allowed them to test in private

### IMPLEMENTATION

- At the end of 2017, the pilot improved implementation by introducing a visual aid to assist with self-sampling: the average proportion of cards with three full spots was 52% prior to the introduction of visual aid, compared to 81% after
- Median time from online registration to lab receipt was 15 days (IQR 11-23), less than the 21 days that was deemed acceptable at beginning of pilot
- \$101,000 was the total cost of marketing, advertising, and printing which included promotional campaigns on dating applications

### MAINTENANCE

- 19%** tested more than once during the pilot
- Website for online self-registration was updated to improve user experience and accuracy of data collection



### CASE STUDY

#### Supporting linkage to care for people diagnosed with HIV in the online self-registration pathway

Chris (pseudonym), a middle-aged gay man living in a city in NSW, requested a DBS kit online to collect a sample at home. Within two weeks of ordering, Chris had received the kit and sent his sample back to the lab. The lab informed the statewide Sexual Health Infolink (SHIL) service of a positive HIV result and SHIL began to contact Chris via his preferred methods of communication. SHIL were able to support Chris when providing his results and to book an appointment at a local sexual health clinic for a confirmatory test. Chris could not make the booked appointment and found it difficult to reschedule due to complex life events. Over ten days, SHIL continued to attempt contact with Chris, bridging the gap between him and the sexual health clinic. When Chris received a positive confirmatory result, SHIL continued follow-up until he attended an appointment for treatment initiation.

The SHIL service offered important support to people who were diagnosed via the online self-registration pathway. Dedicated, non-judgemental follow-up provided via SMS, phone and email, supported people to attend local health services for confirmatory testing and to initiate treatment.

# NSW DBS PILOT AT A GLANCE: ASSISTED REGISTRATION IN THE COMMUNITY

## REACH

**2523** unique people tested

**95%** tested for HIV

**95%** tested for hepatitis C

**65%** were men

**29%** were Aboriginal or Torres Strait Islander

**66%** had recently injected drugs

## EFFECTIVENESS

**53%** had not tested for HIV in the last two years

**44%** had not tested for hepatitis C in the last two years

**13%** tested more than once in the pilot

**NOBODY** was newly diagnosed with HIV

**17%** were diagnosed with hepatitis C

**27%** of people diagnosed with hepatitis C initiated treatment within 6 months

## ADOPTION

**36** community sites had capacity to perform DBS testing by the end of 2020

## IMPLEMENTATION

Median time from sample collection to arrival of sample in lab was **7 DAYS** (IQR 6-8)

## MAINTENANCE

**80%** (29/36) of sites who enrolled in the NSW DBS Pilot, recruited participants in the last six months of the evaluation period indicating that they remain active

### CASE STUDY

#### Integrating peer support to improve hepatitis C treatment uptake in the community

Helen (pseudonym) became aware of the NSW DBS Pilot while using the outreach services of a needle syringe program. Living in a regional town, Helen had limited access to specialist hepatology clinics and may have been reticent to discuss hepatitis C with her GP due to stigma. After testing through the pilot, Helen was informed she had active hepatitis C infection. The team organised transport for Helen to have a hepatitis C assessment in another town. A peer worker was able to follow up via home visits and delivered treatment to Helen so she did not have to attend a pharmacy. Following ongoing check-ins with the peer worker, Helen completed her treatment.

Although there are multiple challenges to reduce gaps in the care cascade for people diagnosed in the community, peer support is an important service to mitigate multilevel stigma faced by people at risk of hepatitis C.



## NSW DBS PILOT AT A GLANCE: ASSISTED REGISTRATION IN PRISON

Testing in prison began mid-2018 and by the end of 2020, testing had been offered in 21 prisons. Testing in prison accounts for 57% of people tested via assisted registration. Testing numbers were affected by the COVID-19 pandemic.

### REACH

**3310** people tested

**85%** were men

**89%** tested for HIV

**59%** were Aboriginal or Torres Strait Islander

**99%** tested for hepatitis C

**49%** had recently injected drugs

### EFFECTIVENESS

**45%** had not tested for HIV in the last two years

**14%** were diagnosed with hepatitis C

**43%** had not tested for hepatitis C in the last two years

**61%** of people diagnosed with hepatitis C initiated treatment within 6 months

**1 PERSON** diagnosed with HIV who initiated treatment within 6 months

### ADOPTION

DBS testing was offered in **21** prisons

The NSW DBS Pilot was primarily deployed in prisons through testing “blitzes” where staff from Justice Health offer testing to a large number of people over 2-3 days

### IMPLEMENTATION

Median time from sample collection to arrival of sample in lab was **6 DAYS** (IQR 3-8)



### CASE STUDY

#### Carrying out testing “blitzes” in prison

The NSW DBS Pilot in prisons is primarily deployed through testing “blitzes” where staff from Justice Health offer testing to a large number of people over 2-3 days. Sites are selected based on a variety of elements such as access to testing and the prevalence of hepatitis C. The Governor / Manager of Security and Nursing Unit Manager(s) give approval for the testing days in advance. Set up for the testing “blitzes” can be complex, and the team needs to liaise with the site to consider access, security, and space to offer testing.

Testing can occur in the wings, pods and work areas of the prison and doesn't require individuals to be escorted to and from the prison health centre. In this way, large number of people can be tested in a short period of time. Testing “blitzes” were publicised with promotional materials including banners, posters, and flyers. Where possible, the Inmate Development Committees were consulted during the preparation for the visit.

External staff, such as peer workers from NUAA and Hepatitis NSW, were another important element of recruitment. Again, they needed to gain prior permission for entry to the prison.

The testing “blitzes” relied upon collaboration of Corrective Service NSW Officers for security, sometimes requiring scheduling of additional staff for support during testing.

The NSW DBS Pilot is an opportunity for people in prison to learn about HIV and hepatitis C testing and possibilities for treatment. People in prison may be reticent to speak about behaviours related to hepatitis C because there are negative consequences to doing so. Delivering this service directly to people in prison is an opportunity to build rapport and open those conversations.

## NSW DBS PILOT AT A GLANCE: MEN WHO HAVE SEX WITH MEN

HIV testing was offered to men who have sex with men (MSM >16 years) from the beginning of the pilot in 2016, via online self-registration. Hepatitis C testing was added to the pilot September 2017 but only offered to MSM who met hepatitis C testing inclusion criteria. Of all MSM, 76% participated via online self-registration.

### REACH

- 1338** MSM tested
- 29%** were born outside of Australia
- 99%** tested for HIV
- 81%** lived in postcodes moderately or sparsely populated with gay men (12)
- 29%** tested for hepatitis C
- 18%** recently injected drugs
- 7%** identified as straight
- 23%** lived outside of major cities

### EFFECTIVENESS

- 50%** had not tested for HIV in the last two years
- 8%** were diagnosed with hepatitis C
- 52%** had not tested for hepatitis C in the last two years
- 43%** initiated treatment within six months
- 0.6%** MSM were newly diagnosed with HIV, all of whom were diagnosed via the online self-registration pathway

Comparable with HIV positivity among gay and bisexual men attending publicly funded sexual health clinics and private GP clinics with high GBM caseloads in NSW which decreased from 2.0% in Quarter 1 2013 to 0.6% in Quarter 4 2021 (13)

### Of **207** MSM surveyed in the online self-registration pathway...

- 91%** liked that they could test in private
- 41%** disliked that it didn't offer the possibility to get a full sexual health check-up
- 88%** thought it was convenient

### IMPLEMENTATION

For MSM registering online, the median number of days from online registration to receipt of sample in lab was **15 DAYS** (IQR 11-24), less than the 21 days which was deemed acceptable at the beginning of the pilot



# NSW DBS PILOT AT A GLANCE: ABORIGINAL AND TORRES STRAIT ISLANDER PEOPLE

From June 2019, Aboriginal and Torres Strait Islander identity was an inclusion criterion for HIV and hepatitis C testing through the NSW DBS Pilot. A higher proportion of Aboriginal and Torres Strait Islander participants accessed testing in prison (63%) than community settings (34%). There were 60 Aboriginal and Torres Strait Islander participants who used the online self-registration pathway.

## REACH

- 2137** Aboriginal and Torres Strait Islander people tested
- 72%** men
- 99%** tested for hepatitis C
- 3%** were men who have sex with men
- 92%** tested for HIV
- 56%** recently injected drugs

## EFFECTIVENESS

- 38%** had not tested for HIV in the last two years
- 0.1%** people newly diagnosed with HIV, both initiated treatment within 6 months
- 43%** had not tested for hepatitis C in the last two years
- 17%** diagnosed with hepatitis C
- 47%** initiated HCV treatment within six months

## IMPLEMENTATION

In the community, assisted registration was available through sexual health services, needle syringe programs and drug treatment clinics but not including Aboriginal Community Controlled Health Services.

## CASE STUDY

### Utility of DBS sampling in remote locations

Diane (pseudonym), a young Aboriginal woman from a remote region took part in the NSW DBS Pilot at a sexual health clinic. Diane had a history of injecting drugs and had never been tested for HIV. The clinic was unable to enrol her in the study online because of poor internet coverage in the area. The Aboriginal Health Worker contacted the state-wide Sexual Health Infolink (SHIL) service for support to collect verbal consent and enrol Diane in the study over the phone. Diane's DBS sample was mailed to the lab and within two weeks she received her HIV negative result via SMS.

DBS sampling requires minimal equipment and can be easily stored, making it ideal for using in remote areas. Remote support from SHIL ensured people could participate in the study in spite of connectivity issues in remote settings. DBS is an important alternative for people who may not have easy access to health services and have never tested for HIV and hepatitis C.

People around the state registered online to test at home for HIV and hepatitis C.

**Figure 5: Number of hepatitis C (blue) and HIV (red) tests performed by postcode in the online self-registration pathway**

Number of HCV tests conducted (online)

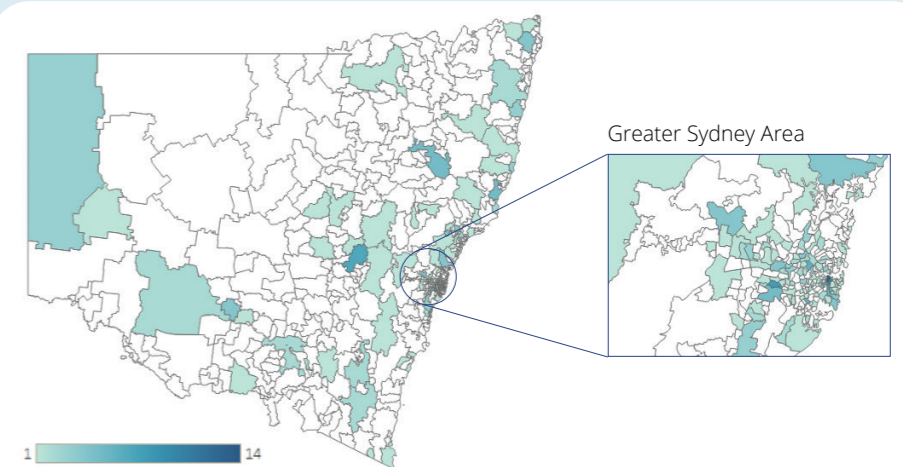

Number of HIV tests conducted (online)

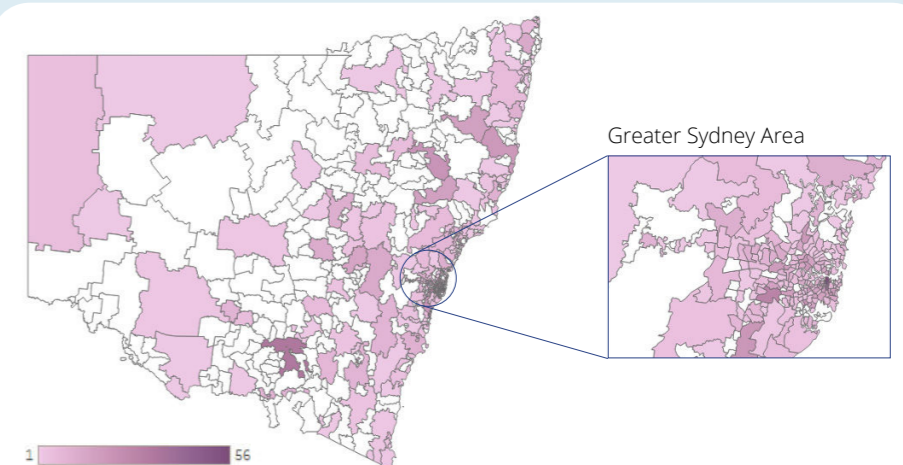

# 1. REACH

By the end of 2020, DBS was available through the pilot via online-self registration and assisted registration at 36 community sites and 21 prisons.

## a How many DBS tests were performed?



**8,696**  
tests performed



**7,392**  
unique participants



**2,212**  
tests via online self-registration  
(that's 25% of all tests)



**130**  
tests via online self-registration  
per quarter (remained stable  
throughout)



**6,484**  
tests via assisted registration



## THE IMPACT OF COVID-19 ON THE NSW DBS PILOT

Figure 6 demonstrates the impact of the first year of the pandemic on pilot implementation. Between Q1 and Q2 2020:

- The total number of tests halved, but online self-registrations stayed stable
- 72% decrease in assisted registration, but returned to previous levels in Q3
- Justice Health registrations dropped by 41% and then exceeded previous levels by Q3

Figure 6: Number of tests performed per quarter by registration pathway

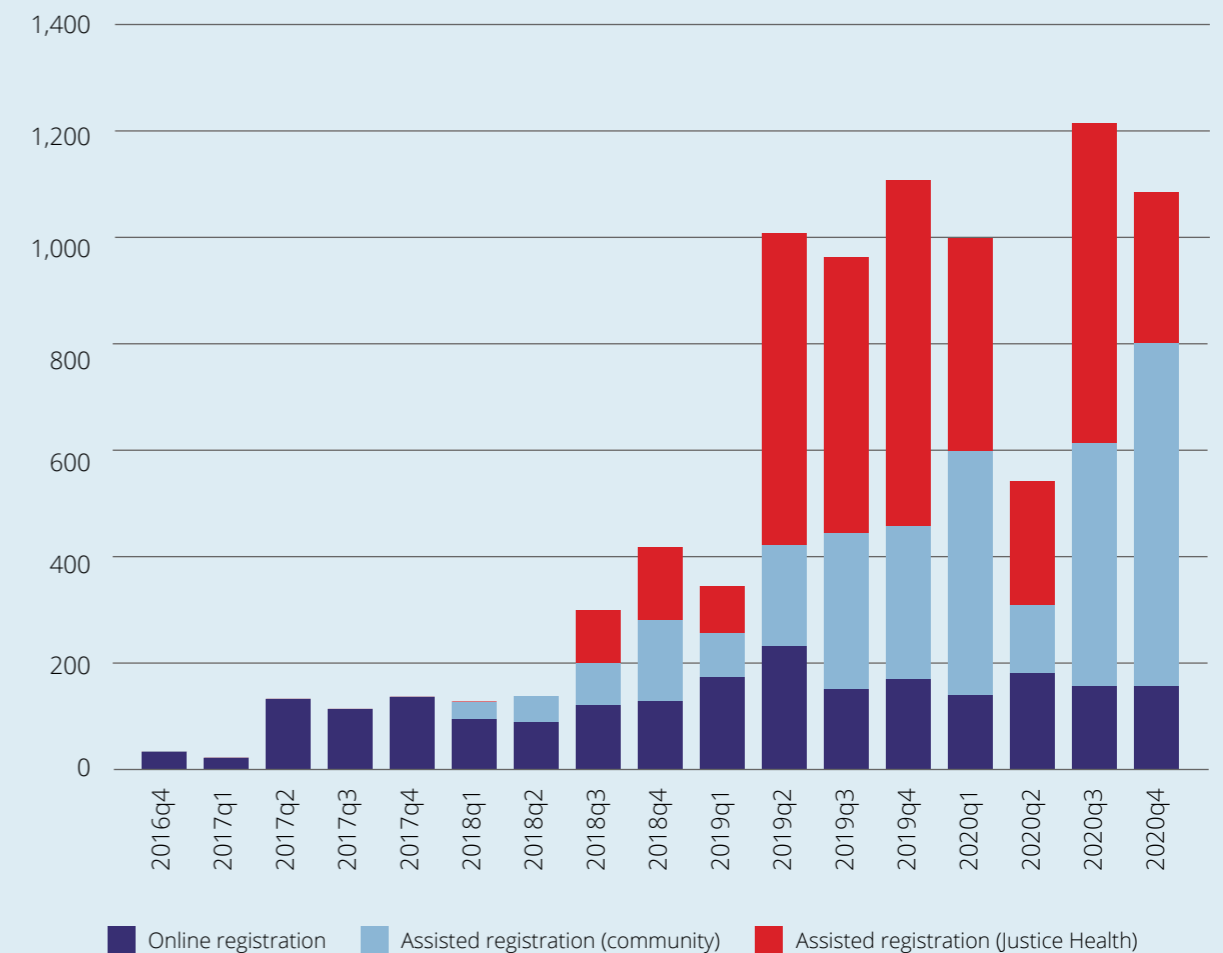



## TYPE OF TEST - HIV AND HEPATITIS C

As the NSW DBS Pilot introduced more testing pathways and changed eligibility criteria, the proportion tested for each disease changed. Initially, all people eligible for hepatitis C testing were eligible for HIV testing. From the end of 2019, people eligible for hepatitis C testing could opt out of HIV testing.

- Hepatitis C testing was added to the pilot in September 2017
- Overall, 74% of participants were tested for both HIV and hepatitis C

**Figure 7: Number of tests performed per quarter by HIV/hepatitis C**

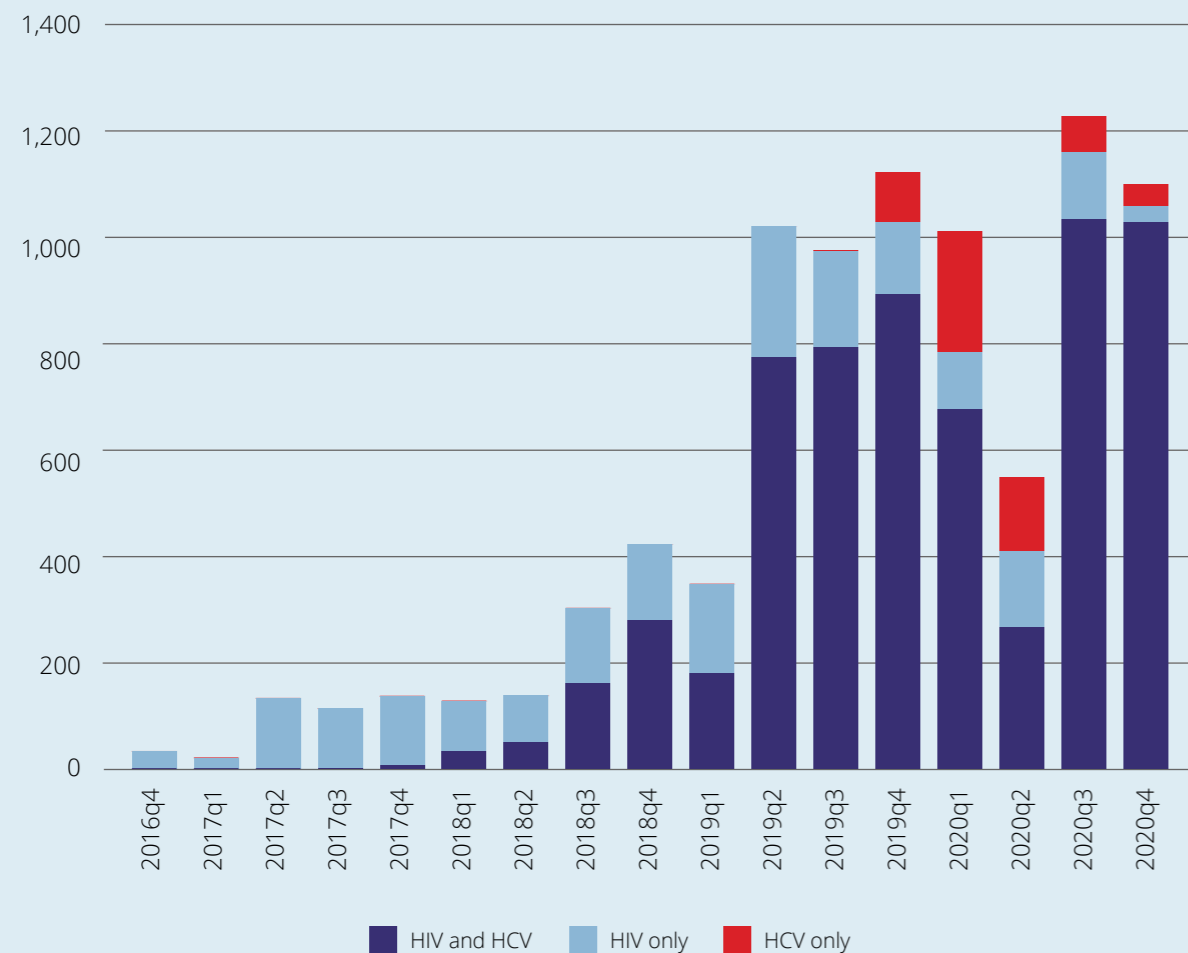

### **b** Demographics - who was tested in online self-registration?

See Supplementary Analyses, [Table 10](#)

- 1559** unique clients
- 2212** tests
- 99%** were tested for HIV
- 18%** were tested for hepatitis C
- 7%** recently injected drugs
- 86%** male
- 65%** men who have sex with men
- 87%** in postcodes moderately or sparsely populated with gay men (12)
- 31%** aged < 25
- 23%** living outside major cities
- 45%** born outside of Australia and 31% in Asia or Africa
- 27%** don't speak English at home

### **c** Demographics - who was tested in assisted registration?

See Supplementary Analyses, [Table 10](#)

- 7392** tests performed
- 5833** unique clients
- 97%** were tested for hepatitis C
- 55%** recently injected drugs
- 92%** were tested for HIV
- 76%** male
- 36%** Aboriginal and/or Torres Strait Islander
- 29%** aged > 45
- 13%** born outside Australia
- 56%** recently injected drugs
- 57%** tested in prison



### CASE STUDY

#### Utility of DBS in community outreach work

Many of the sites who took part in the NSW DBS Pilot operate in a clinic but also offer outreach so they can deliver health services to people who are not already engaged. Christine (pseudonym) was a middle-aged Aboriginal woman who was not familiar with needle syringe program. When the service did outreach in a local neighbourhood, she expressed interest in taking part in the NSW DBS Pilot. While collecting a blood sample, staff were able to discuss Christine's concerns about initiating hepatitis C treatment. After sending the sample to the lab and receiving the result, the site informed Christine that she had active hepatitis C infection. Christine initiated hepatitis C treatment within two months and was supported by the site through delivery of her DAAs and daily medication reminders, until she completed treatment.

Site staff reported that DBS sampling was easy, non-intimidating and quick. This made it a great option for opportunistic testing when teams were on outreach. Dedicated processes to support treatment initiation can ensure people complete treatment despite not being engaged in other health services.

### d Who registered online and returned a DBS sample?

#### See Supplementary Analyses, Table 11

The proportion of returned samples stayed reasonably stable throughout the pilot period, including during the COVID-19 pandemic.

- 64% of online self-registrations returned a sample to the lab
- This is higher than comparable self-sampling services in England (55.5% November 2015 – October 2017 (14))
- 78% of people aged >55 returned a sample

**Figure 8: Number of online self-registrations and proportion of samples returned to lab by quarter**

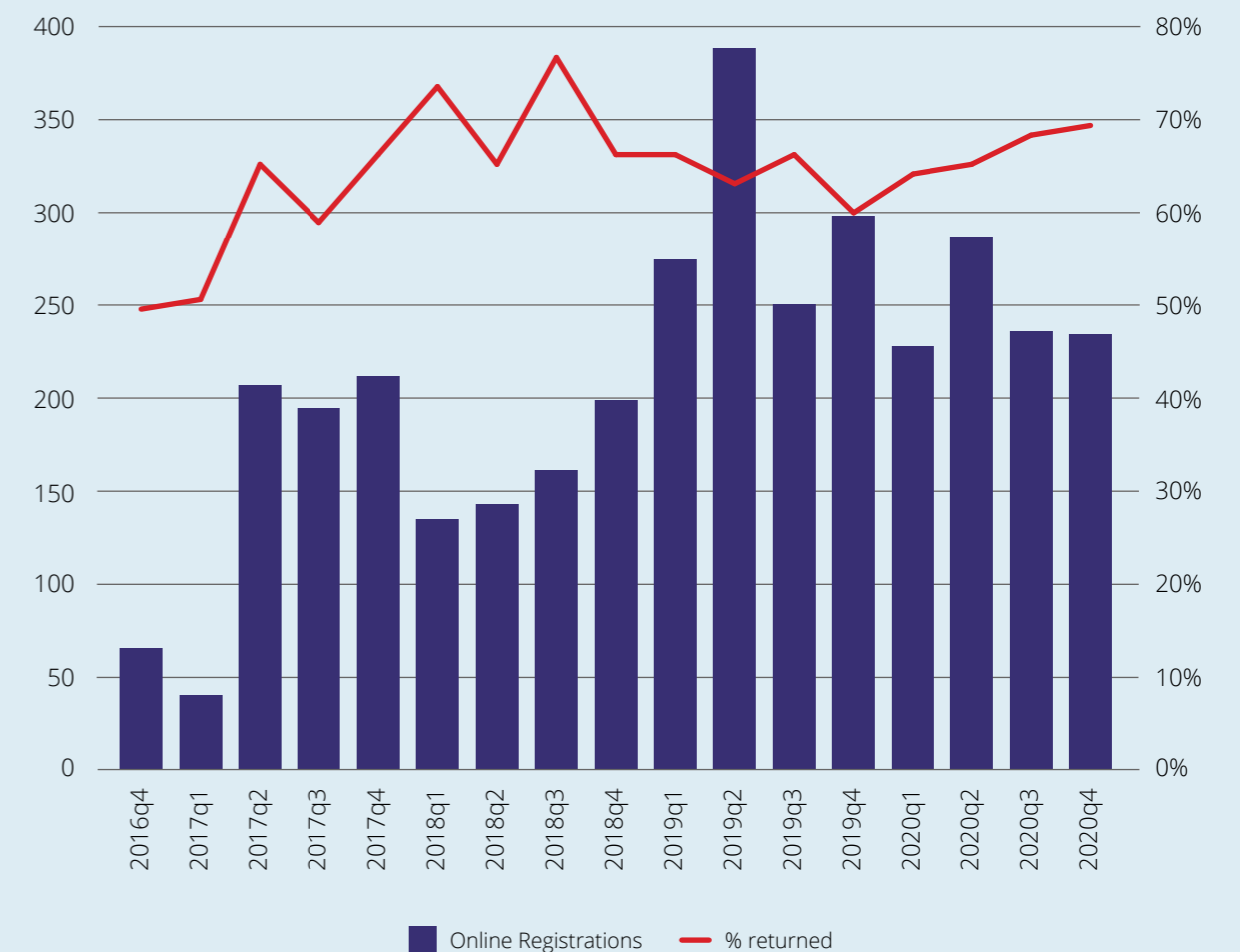

# 2. EFFECTIVENESS

## a What was the HIV testing uptake in people not recently tested?

See Supplementary Analyses, [Table 12](#)

- 50% of the people tested for HIV in the pilot last tested more than two years ago or never
- 53% of men who have sex with men in the online self-registration pathway had last tested for HIV more than two years ago or never. This is higher than the 2015-19 Sydney Gay Community Periodic Survey, which reported 22% of gay men had not tested in the previous year (15)

The online self-registration pathway was more effective than assisted registration at testing people who reported no recent HIV test, overall and for key populations.

**Figure 9: People not tested for HIV in the two years prior to enrolment by registration type**



## b What was the hepatitis C testing uptake in people not recently tested?

See Supplementary Analyses, [Table 13](#)

A question on previous hepatitis C testing was introduced to the survey in September 2019 and so this information was only available for a subset of participants (n=4112).

- In the online self-registration pathway, 74% of people tested for hepatitis C had not tested in the two years prior to registration compared to 43% in assisted registration
- 90% of people who injected drugs had tested for hepatitis C in their lifetime. This is comparable with Australian 2017 estimates that 89% of people who inject drugs had a lifetime history of hepatitis C antibody testing (16)
- Among participants in the assisted registration pathway, the proportion with no hepatitis C test in the two years prior to enrolment was 37% among Aboriginal and Torres Strait Islander people, 41% among people born in Australia and 32% among people who recently injected drugs

**Figure 10: People not tested for hepatitis C in the two years prior to enrolment by registration type**

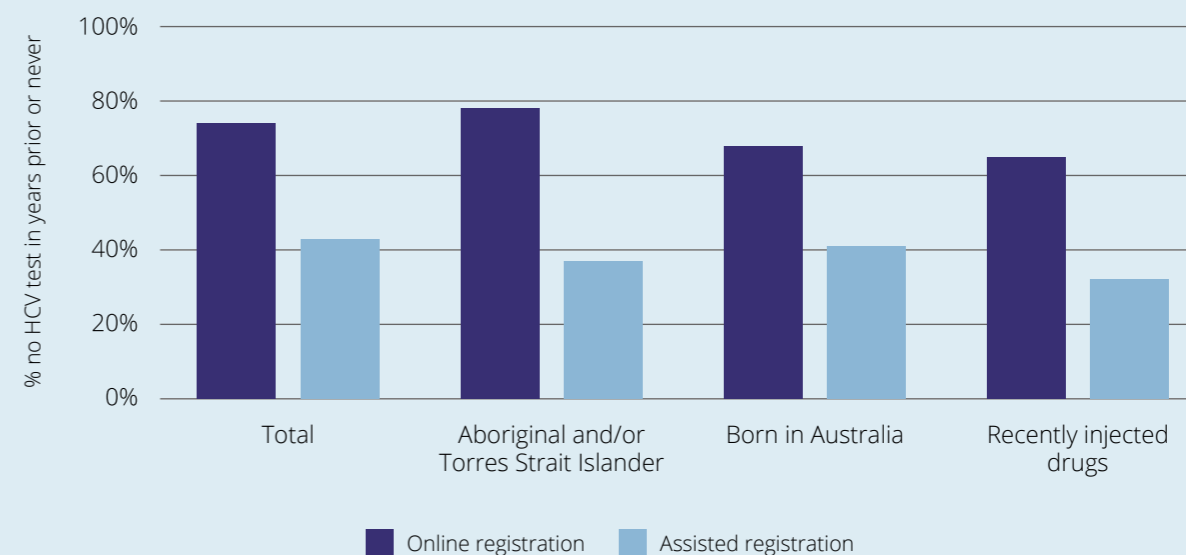

## c Who was newly diagnosed with HIV and who initiated treatment?

See Supplementary Analyses, [Table 15](#)

Of 6922 unique people tested for HIV, 10 people were newly diagnosed (0.1%)

- 9 people newly diagnosed in the online self-registration pathway (0.6%)
- 1 person newly diagnosed in prison (0.03%)
- All were men and 8 were men who have sex with men
- 4 were born outside of Australia

Of 10 people newly diagnosed, 8 initiated treatment within 6 months. Of those who did not initiate treatment within 6 months, one returned to his home country.

**d Who was diagnosed with hepatitis C?**

See Supplementary Analyses, [Table 16](#) and [Table 17](#)

- Of 5960 unique clients, 878 (15%) had current hepatitis C infection
  - 17% via assisted registration in the community
  - 14% via assisted registration in prison
  - 5% via online self-registration
- The proportion of people diagnosed with current HCV infection via assisted registration in the community (17%) was comparable to Australian studies in drug treatment clinics (Estimated at 17% in ETHOS Engage (17))
- Aboriginal and/or Torres Strait Islander people, people who spoke English at home and recently injected drugs had a higher proportion of current hepatitis C infection in both online self-registration and assisted registration pathways.
- Due to changes in the survey in 2019, the collection of data on gender was not consistent. The category “other” is defined as non-binary, gender fluid, different identity or prefer not to answer (options only available from 2019 onwards) and 23% (12/53) of people categorised as “other” were diagnosed with current hepatitis C infection

**Figure 11: Proportion of people diagnosed with hepatitis C**

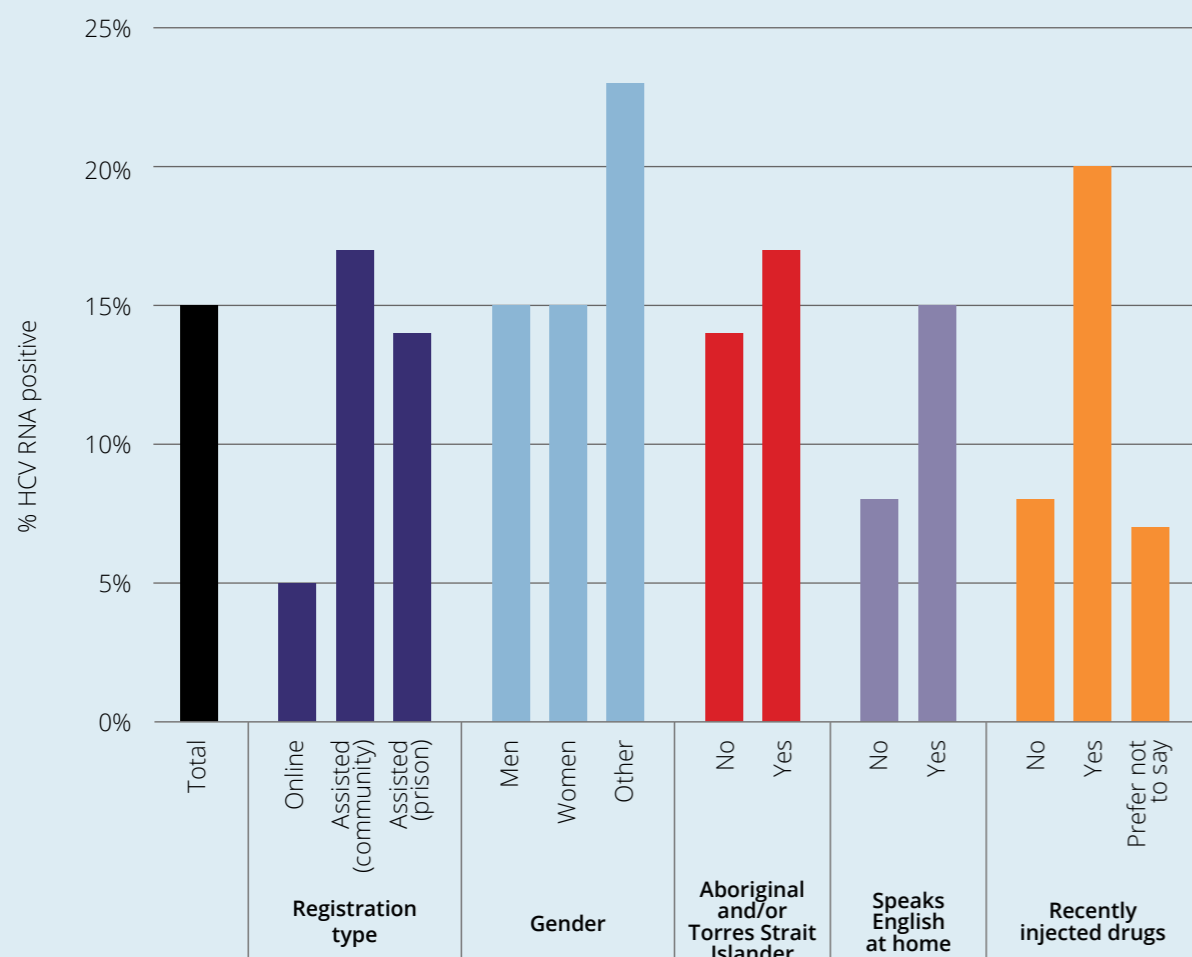

**e Who initiated treatment after being diagnosed with hepatitis C?**

See Supplementary Analyses, [Table 18](#) and [Table 19](#)

- Of the 878 people with current hepatitis C infection:
  - 61% had a confirmatory test within six months
  - 45% initiated hepatitis C treatment within six months
- Treatment initiation was higher in assisted registration in prison than community (61% vs 27%)
- Treatment initiation was higher in men than women (49% vs 32%)
- Treatment initiation was higher among Aboriginal and Torres Strait Islander people than other participants (49% vs 42%)
- Treatment initiation was higher among people living in major cities (47% vs 31%)
- People aged under 25 had a higher proportion of treatment initiation (61%) than all other age groups

**Figure 12: Proportion of people who initiated treatment within six months after being diagnosed with hepatitis C**

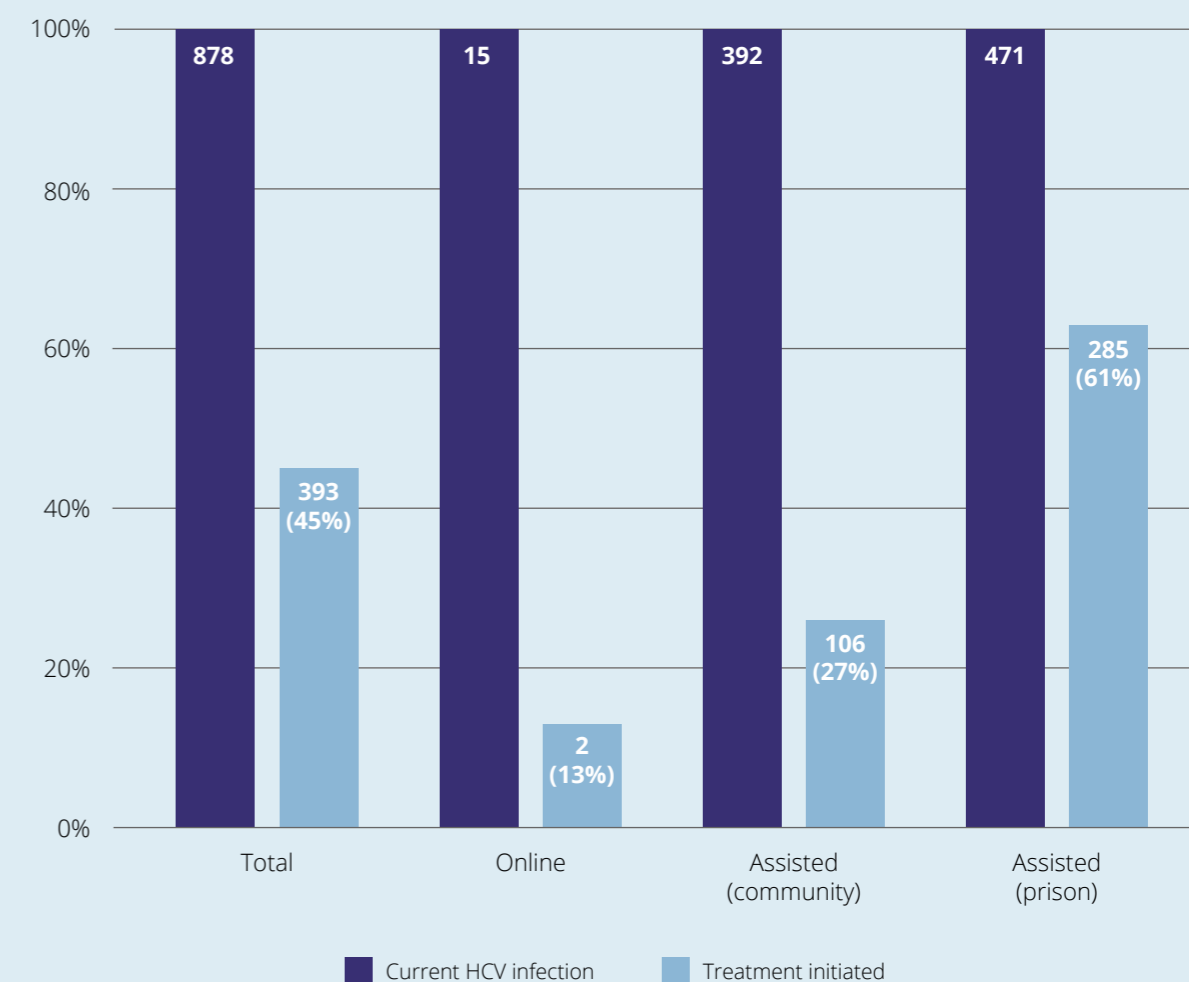

## CASE STUDY

### Challenges in linkage to care for people diagnosed in the community

While attending a drug and alcohol service, Maria (pseudonym) decided to take part in the NSW DBS Pilot using the assisted registration pathway. Maria injected drugs and had a history of incarceration. She wanted to test for HIV and hepatitis C because she had not tested in the few years prior. Staff at the service helped her register for the study and collected a DBS sample which was sent to the lab. When she was diagnosed with hepatitis C, SHIL delivered the results by phone. Maria was keen to start treatment and agreed for SHIL to liaise with her drug and alcohol service to arrange linkage to care. The clinic referred SHIL to a GP but the GP did not respond over three months of repeated contact by phone and email until Maria was considered lost to follow-up.

There were challenges in integrating the NSW DBS pilot at the site level. While testing at community sites reached key populations and found a relatively high prevalence of hepatitis C, only 27% of people initiated treatment within six months. Participating sites need clear care pathways for people diagnosed by DBS sampling.



## f How acceptable was the pilot to people using online self-registration?

A survey of acceptability was introduced in June 2017 with participants in online self-registration. Of 259 respondents, 80% were men who have sex with men.

- The NSW DBS Pilot process was assessed as quite or very easy by 96% of respondents.
- “Understanding how to do the test” and “Ordering the test” was assessed as quite or very easy by 95% and 93% of respondents respectively.
- The most difficult part of the process was “Getting enough blood to fill five circles” - assessed as quite or very easy by 63%.

**Figure 13: Survey results on ease of use and helpfulness of instructions for online self-registration pathway (N=259), NSW DBS Pilot June 2017**

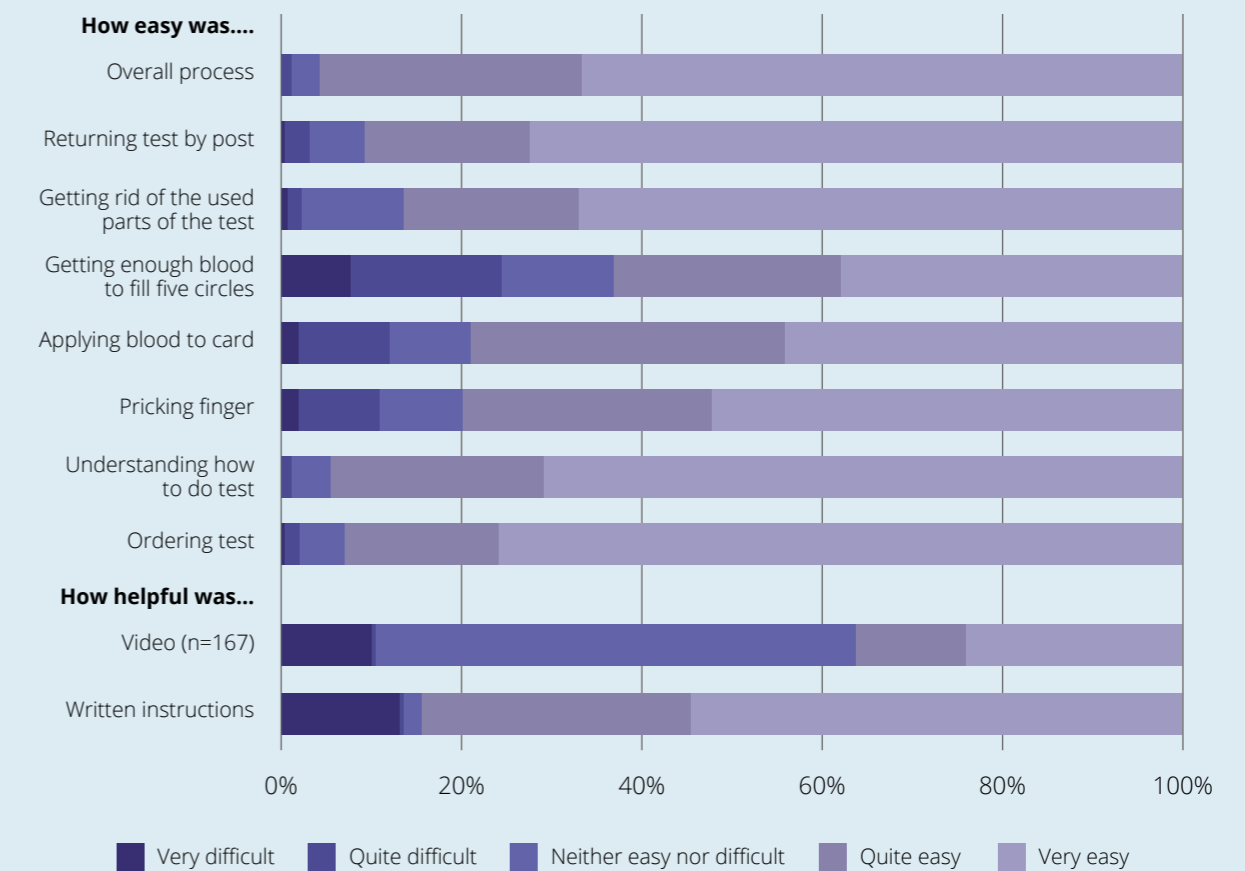

**“I WAS MORE COMFORTABLE HAVING THE TEST THIS WAY AS I FELT THAT I DIDN'T HAVE TO EXPLAIN TO ANYONE WHY I WAS TAKING IT”**

- Survey respondent who used the online self-registration pathway.

The survey also asked people what they liked and disliked about online self-registration

- The majority of respondents liked that they could test in private (91%), it was convenient (88%) and free (87%)
- Around a third disliked that the DBS test did not allow for a full sexual health check (38%) and around a fifth disliked the waiting time to receive the result (22%)

**Table 1: Survey results on likes and dislikes for online self-registration pathway, NSW DBS Pilot June 2017**

	Overall	
	N	% col
<b>Total</b>	<b>259</b>	
<b>I liked...</b>		
I can test in private	236	91%
It is convenient	227	88%
It is free	226	87%
No need to go to a doctor or clinic just to have a test	214	83%
It is quick	182	70%
Allows me to test when I want	164	63%
It is less embarrassing than asking for a test at a clinic	149	58%
Does not require much blood to be taken	90	35%
Does not involve needles	52	20%
<b>I disliked...</b>		
Not possible to have a full sexual health check at the same time	98	38%
The waiting time to receive the result	58	22%
Having to post it	17	7%
It involves blood for testing	16	6%
Difficult to perform	12	5%
No health professional was there when I tested	6	2%
Being alone when I took my sample	3	1%

## 3. ADOPTION

### a How many sites now have capacity to perform DBS testing?

By the end of 2020, DBS via assisted registration was available through the pilot at 36 community sites and 21 prisons.

- Dried Blood Spot testing is offered by a range of government services in every NSW Local Health District. These include Drug and Alcohol Services (such as opioid treatment programs), Needle and Syringe Exchange services, HIV and related Program services, Sexual Health services, Liver Clinic services, and outreach to community pharmacies and community-based organisations such as homelessness services. Testing occurs at fixed sites and also via outreach to neighbouring suburbs and towns within each region.
- DBS testing was also offered by three private sites ACON, The Gender Centre and WHOS Drug Rehab service.

#### Assisted Registration in Local Health Districts (LHDs)

##### Central Coast

Gosford, Woy Woy, Long Jetty, Wyong

##### Far Western NSW

Broken Hill, Dareton, Wilcannia

##### Hunter New England

Tamworth, Moree, Inverell, Armidale

##### Illawarra ShoalHaven

Warrawong, Nowra, Wollongong

##### Mid North Coast and Northern NSW

Port Macquarie, Kempsey, Coffs Harbour, Grafton

##### Murrumbidgee

Wagga Wagga, Griffith, Albury

##### Nepean Blue Mountains

Kingswood, Penrith, Windsor, Wilberforce, Glenbrook, Katoomba, Lithgow

##### Northern Sydney

St Leonards, Brookvale

##### South Eastern Sydney

Darlinghurst, Kings Cross, Woolloomooloo, Martin Place, Redfern, Surry Hills, Kogarah, Sutherland, Rockdale, Little Bay, Waverley

##### Southern NSW

Queanbeyan, Goulbourn, Bateman's Bay, Moruya, Narooma, Bega, Pambula, Eden

##### South Western NSW

Campbelltown, Fairfield, Liverpool, Bankstown, Prairiewood

##### Sydney

Redfern, Canterbury, Chippendale, Newtown, Summer Hill, Camperdown, Ashfield, Riverwood

##### Western NSW

Dubbo, Bourke, Lightning Ridge, Orange, Bathurst

##### Western Sydney

Parramatta, Blacktown, Mount Druitt

The NSW DBS Pilot offered testing at 21 prisons. It was primarily deployed through testing "blitzes" where staff from Justice Health offer HIV and/or HCV testing to a large number of people at one site over 2-3 days.

#### Prison site

Dilwynia/South Winsor 2756

Emu Plains/ Emu Plains 2751

Geoffrey Pearce/ South Windsor 2756

Glenn Innes/ Glenn Innis 2370

Goulburn/ Goulburn 2580

Hunter/ Cessnock 2325

John Marony/ South Windsor 2756

Kariong/ Kariong 2250

Kirkconnell/ Kirkconnell 2795

Lithgow/Lithgow 2790

Long Bay /Malabar 2036

Macquarie/ Wellington

Mannus/Tumbarumba 2653

Mary Wade/Lidcombe 2141

MRRC /Silverwater 1811

Mid North Coast/Kempsey West 2440

Shortland /Cessnock 2325

Silverwater Women's /Silverwater 1811

South Coast /Nowra 2541

Tamworth /Tamworth 2340

Wellington /Wellington 2820



# 4. IMPLEMENTATION

A core aim of the assisted testing pathway was to recruit and on-board new sites that previously had limited HIV or hepatitis C testing capacity and can now offer it as a viable testing alternative.

- Sites included sexual health services, drug treatment clinics and needle syringe programs
- 36 sites had received approval to participate in the study by the end of 2020
- At the end of 2020, several additional sites were in the process of being approved:
  - Central Coast HARP/DACS
  - HNE DACS (Southern)
  - Northern Sydney Primary and Community Health
  - NSLHD Brookvale Community Health
  - Western NSW Mental Health & Drug and Alcohol Service
  - Junee Correctional Centre
  - Clarence Correctional Centre
  - Matthew Talbot Hostel
  - NSW Users and AIDS Association
  - Hepatitis NSW
  - Pharmaceutical Society of NSW

**Figure 14: Number of sites participating in assisted registration and tests performed in the community by quarter**

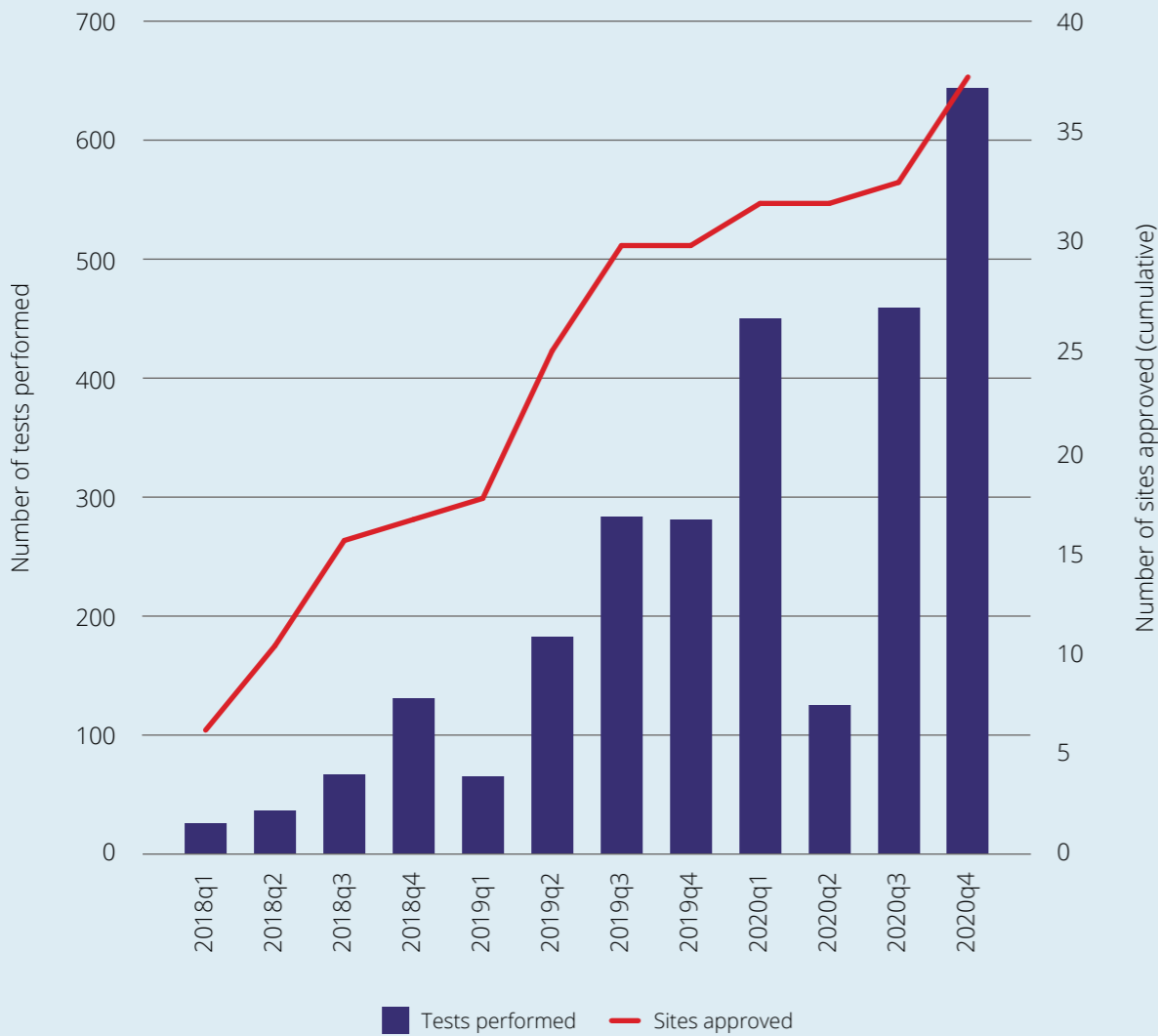

**a Which sites returned samples after DBS kits were distributed to them?**

For the assisted registration pathway, 13,814 DBS kits were distributed to sites. Overall, 50% of those had returned a sample by the end of 2020.

Sites and events that had not signed up to the pilot were able to distribute kits to participants to complete at home. A stocktake may determine whether sites are storing kits that have not been distributed, or if kits have been distributed which have not been returned. There is some indication of low return rates when kits were provided to take home.

**Table 2: Distribution and return of testing kits by site**

	Number distributed	Number returned	% returned
<b>Total</b>	<b>13814</b>	<b>6938</b>	<b>50%</b>
Justice Health and Forensic Mental Health Network	5070	3815	75%
Kirketon Road Centre	1201	797	66%
ACON	1080	54	5%
Illawara Shoalhaven Drug & Alcohol Service	660	244	37%
Pharmacy and other	483	121	25%
South Western Sydney LHD	470	220	47%
Sydney LHD	450	64	14%
Nepean Blue Mountains	400	269	67%
Far Western Primary Health Care	350	83	24%
South Western Sydney Drug Health Service	340	254	75%
Festival/event	339	47	14%
Mid North Coast	330	125	38%
Western Sydney Drug Health Service	310	130	42%
South Western Sydney Liver	210	70	33%
Northern NSW	200	12	6%
Sydney Drug Health Services	180	98	54%
Western NSW	180	34	19%

	Number distributed	Number returned	% returned
iCHAT	150	104	69%
Rankin Court	140	92	66%
The Beaches Clinic	140	19	14%
Orange	120	102	85%
The Gender Centre	120	2	2%
Liverpool Sexual Health	130	29	22%
Lismore Liver Clinic	100	20	20%
Sydney Gastro and Liver	100	39	39%
WHOS	100	0	0%
DACS undefined	81	22	27%
Northern Sydney Drug and Alcohol Brookvale	70	24	34%
NUAA	70	19	27%
Southern NSW LHD	70	1	1%
Hunter New England Drug and Alcohol Service	50	4	8%
Illawara Shoalhaven Sexual Health	50	14	28%
Northern Sydney Drug and Alcohol Service	40	8	20%
The Orana Centre	30	2	7%

**b What proportion of returned DBS cards had sufficient sample?**

A standardised training was provided to NSW DBS Pilot sites to ensure adherence to the protocol. Training included best practice on sample collection: collecting at least three full spots on blood on the DBS card. By the end of 2017, it was noted by the laboratory that the quality and suitability of samples from people self-sampling (ie. unassisted) was poor and not consistent with the requirements of the protocol. A visual aid was introduced into the kits and online instructions at this time which improved adherence to the protocol (see following page).

- 90% of cards had the three full spots was but this increased throughout the pilot
- For online self-registration, the average proportion of cards with three full spots was 52% until the end of 2017, compared to 81% for the period after the introduction of the visual aid for sample collection (2018-2020)

FIGURE 15: VISUAL AID TO ASSIST IN COLLECTION OF DBS SAMPLE

**DBS**  
DRIED BLOOD SPOT SAMPLE COLLECTION INSTRUCTIONS

- 1 Register online**  
Go to [www.dbstest.health.nsw.gov.au](http://www.dbstest.health.nsw.gov.au) to get your validation code.
- 2 Check kit contents**  
test card, lancet (for pricking finger), alcohol swabs, band-aids, cotton balls, foil envelope, reply paid envelope.
- 3 Write name, date of birth and validation code on test card**  
Your validation code was sent to your phone or email.
- 4 Wash hands with warm water**
- 5 Wipe finger with alcohol swab and allow to dry**
- 6 Prick finger with lancet**  
Twist off cap, Push hard against finger and push until it "clicks".
- 7 Squeeze blood onto card**  
Large drop of blood into each circle. Minimum 3 full spots required.
- 8 Wipe finger and apply band-aid**
- 9 Allow test card to dry**  
4+ HOURS. When dry, fold the flap of the test card over the blood spots.
- 10 Pack test kit into foil envelope and reply paid envelope**
- 11 Post test kit**  
Free postage - no stamp required.

**Dried Blood Spot Collection Criteria**  
Perfect Collection (3 full spots) ✓  
Rejected Collection (incomplete spots) ✗

**Need Help?**  
Watch the video at [www.dbstest.health.nsw.gov.au](http://www.dbstest.health.nsw.gov.au)  
Or call Sexual Health Infolink on 1800 451 624

NSW GOVERNMENT Health



**Figure 16: Proportion of DBS cards returned with three full spots by quarter and registration type**

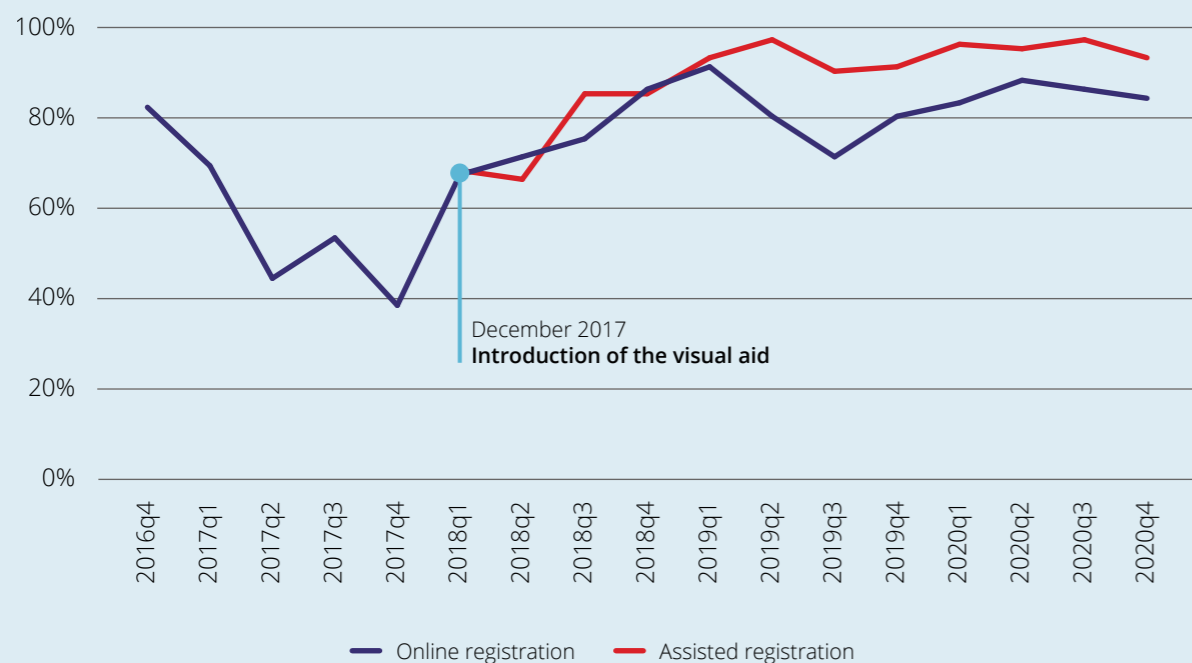

**C What was the time from registration to arrival of sample in lab?**

Median time from registration to receipt of sample in the lab was longer for online self-registration given the additional time needed for the sampling kit to be delivered to homes by post.

- 15 days (IQR 11-23) was the median number of days from online self-registration to testing in lab
- The time from collection to arrival in lab was higher for online self-registrations. This could reflect a longer wait time at home or a longer delivery time due to location
- Time from arrival in lab to test was similar across registration types

**Figure 17: Median number of days of each stage of DBS testing by registration type**

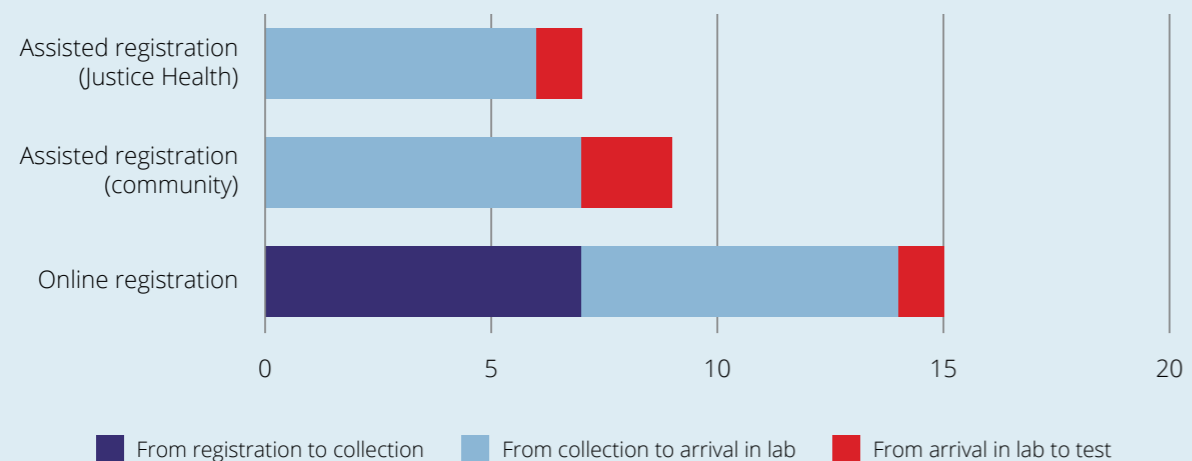

**d What was the cost per test, diagnosis and treatment initiation for HIV and hepatitis C?**

See Annex 4 for methodology.

Health economic and costing analyses of the NSW DBS Pilot are critical to inform decision making about the relative efficiency of DBS testing for further scale-up and implementation in NSW. As such, this analysis forms a critical component of the evaluation of the NSW DBS Pilot.

This section reports the total program costing for the NSW DBS Pilot. The work will inform a second phase of the analysis, a cost-effectiveness and budget impact analyses for hepatitis C.

**i NSW DBS Pilot program overall cost**

Total costs of the pilot program were estimated from the provider/funder perspective for the period of November 2016 to December 2020. Total costs associated with delivering the intervention included online self-registration and assisted registration pathways. Costs were sourced from the financial information provided by the DBS pilot program and included participant registration, DBS testing site staff time, pathology lab, and pilot program coordination. Total cost of the DBS pilot program over 4 years was \$2 million (Table 3).

**Table 3: DBS Pilot Program Costs (base case)**

	Postal pathway	Setting pathway	Total costs	
Fixed cost	\$163,286	\$283,668	\$446,954	
Variable cost	\$53,419	\$53,689	\$107,108	
<b>Testing site staff</b>		<b>Community</b>	<b>Prison</b>	
Negative case		\$61,578	\$104,942	\$166,520
Positive case		\$22,467	\$98,826	\$121,293
<b>Pathology lab</b>	<b>HIV only</b>	<b>Hepatitis C only</b>	<b>HIV + hepatitis C</b>	
DBS test	\$44,761	\$37,295	\$470,523	\$552,578
HIV Western Blot test	\$4,711	-	-	\$4,711
<b>Program coordination</b>				
Coordination	\$568,325			\$568,325
Training	\$77,796			\$77,796
<b>Total Program Costs</b>				<b>\$2,045,285</b>

Common costs shared by HIV and hepatitis C combined tests were allocated in two ways: equal distribution and marginal distribution (hepatitis C as the main test). Costs are reported at three levels: direct testing cost only, operational cost (direct testing plus fixed costs), total program cost (Table 4).

## ii Direct Cost

Direct costs contained the minimum resource requirements to perform a DBS test. They include variable costs of DBS testing kit consumables, delivery postage of kits, site staff time, laboratory testing, and Western Blot confirmation for HIV. Direct costs for HIV and hepatitis C were \$300,666 and \$651,544 respectively by equally distributed shared costs.

## iii Operational Cost (base case)

The base case of the cost analysis in this report was built on operational costs (direct testing costs plus fixed costs). The base case reflected upon the resource requirements of performing test and reporting results and communication with sufficient capacity between staff and participants as well as staff between lab/sites/SHIL. In addition to the direct costs of performing a DBS test, there were fixed costs of IT facilities, Sexual Health Information Line (SHIL) staff, pilot promotion and translation, and site staff training for DBS sampling. Costs for HIV and hepatitis C in the base case were \$588,521 and \$888,439 respectively by equally distributed shared costs.

## iv Total Program Cost

Total program costs denoted the overall financial requirements of the NSW DBS pilot program in the 4.1 years since it commenced operation. It encompassed direct, indirect, and program coordination costs. Total program costs for HIV and hepatitis C were \$900,280 and \$1,145,006 respectively by equally distributed shared costs.

## v Average cost per test

Over 4.1 years, there were 8134 HIV and 6694 hepatitis C tests performed. By equally distributing the shared costs, the average cost per HIV test was \$37 and \$97 for hepatitis C test. In the case that people were primarily tested for hepatitis C with HIV as an optional add-on, the average cost per HIV test would be \$22 and \$115 for hepatitis C by attributing the shared costs to hepatitis C (Table 4). The second approach by marginal distribution of the shared costs provides an indication for future decision making based on costings where the setting is primarily offering hepatitis C testing, with or without HIV test.

**Table 4: Costs of testing for HIV and hepatitis C by three levels with shared costs distribution by two approaches**

	I: Equal distribution		II: Marginal distribution	
	HIV	Hepatitis C	HIV	Hepatitis C
<b>Cost (\$A)</b>				
Direct cost	\$300,666	\$651,544	\$181,982	\$770,228
Operational cost	\$588,521	\$888,439	\$469,837	\$1,007,123
Total program cost	\$900,280	\$1,145,006	\$781,596	\$1,263,689
<b>Test</b>	8134	6694	8134	6694
<b>Direct cost per test</b>	\$37	\$97	\$22	\$115
<b>Outcome (Person)</b>				
DBS diagnosis & follow-up	10	878	10	878
Treatment initiated	8	393	8	393
<b>cost per diagnosed case</b>				
Direct cost	\$30,067	\$742	\$18,198	\$877
Operational cost	\$58,852	\$1,012	\$46,984	\$1,147
Total program cost	\$90,028	\$1,304	\$78,160	\$1,439
<b>cost per treatment initiated</b>				
Direct cost	\$37,583	\$1,658	\$22,748	\$1,960
Operational cost	\$73,565	\$2,261	\$58,730	\$2,563
Total program cost	\$112,535	\$2,914	\$97,699	\$3,215

## vi Cost-outcome analysis

Cost-outcome ratios are reported by average cost per diagnosed case and average cost per treatment initiated.

The cost of newly diagnosing a person with HIV in the NSW DBS Pilot was \$30,000-\$90,000 and the cost of initiating treatment for a person newly diagnosed was \$38,000-\$113,000.

For the base case of hepatitis C, considering the operational cost (direct plus fixed costs), the average cost per diagnosis was \$1,000-\$1,100 per case detected. The average cost hepatitis C treatment initiation was \$2,300-\$2,600 (Table 4).

Considering the assisted registration pathway, it was less expensive to diagnose one person with current hepatitis C infection in the community than in the prison (\$769 vs. \$1029 in the base case with operational cost). It was more expensive for one person to initiate treatment in the community than in prison (\$2,845 vs. \$1,700) because of higher treatment uptake in the prison (27% community vs. 61% prison). Through the online self-registration pathway, the average cost of diagnosing a current hepatitis C infection was almost five times more than the average cost by assisted registration in the community (Table 5, Figure 18).

If a DBS program primarily tests for hepatitis C and so hepatitis C incurs the shared costs (e.g. postage, testing site staff time) for combined HIV and hepatitis C tests, the average cost for one hepatitis C diagnosis would increase from \$769 to \$887 in the community and \$1,029 to \$1,179 in prison. The average cost per one hepatitis C treatment initiation would increase from \$2,845 to \$3,280 in the community and \$1,700 to \$1,948 in prison (Table 6).

**Table 5: Costs and average costs per case in three testing settings with shared costs equally distributed**

	Self-sampling		Community		Prison	
	HIV	HCV	HIV	HCV	HIV	HCV
<b>Cost (\$A)</b>						
Direct cost	\$97,332	\$31,177	\$93,558	\$224,060	\$122,499	\$382,709
Operational cost	\$247,919	\$57,491	\$170,560	\$301,517	\$213,975	\$484,621
Total program cost	\$332,585	\$72,286	\$274,352	\$405,922	\$337,276	\$621,988
<b>Outcome (Person)</b>						
DBS diagnosis & follow-up	9	15	0	392	1	471
Treatment initiated	7	2	0	106	1	285
<b>\$ per diagnosed case</b>						
Direct cost	\$10,815	\$2,078	-	\$572	\$122,499	\$813
Operational cost	\$27,547	\$3,833	-	\$769	\$213,975	\$1,029
Total program cost	\$36,954	\$4,819	-	\$1,036	\$337,276	\$1,321
<b>\$ per treatment initiated</b>						
Direct cost	\$13,905	\$15,589	-	\$2,114	\$122,499	\$1,343
Operational cost	\$35,417	\$28,746	-	\$2,845	\$213,975	\$1,700
Total program cost	\$47,512	\$36,143	-	\$3,829	\$337,276	\$2,182

**Table 6: Costs and average costs per case in three testing settings with shared costs incurred by hepatitis C testing**

	Online self-registration		Assisted registration, community		Assisted registration, prison	
	HIV	HCV	HIV	HCV	HIV	HCV
<b>Cost (\$A)</b>						
Direct cost	\$95,263	\$33,246	\$47,411	\$270,206	\$52,030	\$453,178
Operational cost	\$245,850	\$59,560	\$124,414	\$347,664	\$143,507	\$555,090
Total program cost	\$330,516	\$74,355	\$228,206	\$452,069	\$266,807	\$692,457
<b>Outcome (Person)</b>						
DBS diagnosis & follow-up	9	15	0	392	1	471
Treatment initiated	7	2	0	106	1	285
<b>\$ per diagnosed case</b>						
Direct cost	\$10,585	\$2,216	-	\$689	\$52,030	\$962
Operational cost	\$27,317	\$3,971	-	\$887	\$143,507	\$1,179
Total program cost	\$36,724	\$4,957	-	\$1,153	\$266,807	\$1,470
<b>\$ per treatment initiated</b>						
Direct cost	\$13,609	\$16,623	-	\$2,549	\$52,030	\$1,590
Operational cost	\$35,121	\$29,780	-	\$3,280	\$143,507	\$1,948
Total program cost	\$47,217	\$37,177	-	\$4,265	\$266,807	\$2,430

**Figure 18: Average cost per hepatitis C case diagnosed and treatment initiation in three testing settings**

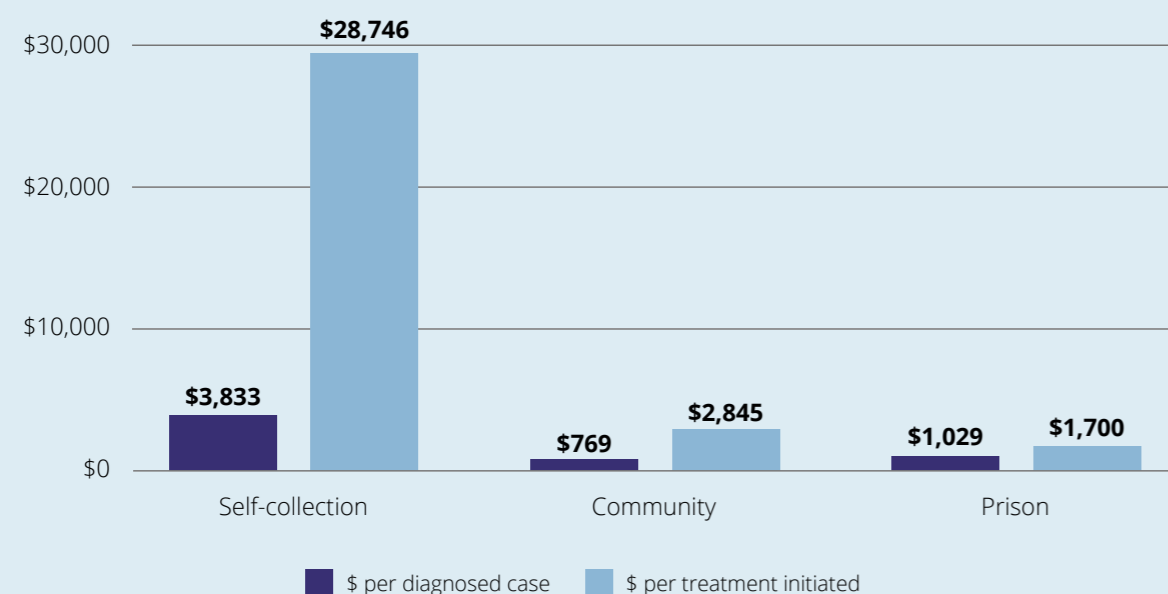

**vii Sensitivity Analysis**

Sensitivity analyses were conducted on the labour costs of the laboratory testing as preparation of the DBS puncture and testing procedures because the combined HIV and hepatitis C does not double the time required for a single test. The base case took the labour cost \$8.75 per single test and \$0 marginal cost for the second test (\$8.75 + \$0 for HIV+ hepatitis C). The low and high ranges of the labour cost per test were \$0 (labour exclusive) and \$17.5 (\$8.75 marginal cost for the second test) respectively.

Use of three different estimates of laboratory labour cost does not have significant impact on the average cost of case diagnosed (hepatitis C \$1,012, ranges \$976~\$1,042) and treatment initiation (hepatitis C \$2,261, ranges \$2,180~\$2,329). Table 7 presents the costs and average costs with low estimates of pathology labour costs and Table 8 with high estimates of pathology labour costs.

# 5. MAINTENANCE

**Table 7: Costs and average costs with low estimate of pathology labour costs (labour exclusive)**

	I: Equal distribution		II: Marginal distribution	
	HIV	HCV	HIV	HCV
<b>Cost (\$A)</b>				
Direct cost	\$256,290	\$619,768	\$164,403	\$711,655
Operational cost	\$544,145	\$856,663	\$452,259	\$948,550
Total program cost	\$855,904	\$1,113,230	\$764,017	\$1,205,117
<b>Direct cost per test</b>	\$32	\$93	\$20	\$106
<b>cost per diagnosed case</b>				
Direct cost	\$25,629	\$706	\$16,440	\$811
Operational cost	\$54,415	\$976	\$45,226	\$1,080
Total program cost	\$85,590	\$1,268	\$76,402	\$1,373
<b>cost per treatment initiated</b>				
Direct cost	\$32,036	\$1,577	\$20,550	\$1,811
Operational cost	\$68,018	\$2,180	\$56,532	\$2,414
Total program cost	\$106,988	\$2,833	\$95,502	\$3,066

**Table 8: Costs and average costs with high estimate of pathology labour costs (labour inclusive)**

	I: Equal distribution		II: Marginal distribution	
	HIV	HCV	HIV	HCV
<b>Cost (\$A)</b>				
Direct cost	\$327,463	\$678,341	\$235,576	\$770,228
Operational cost	\$615,318	\$915,236	\$523,431	\$1,007,123
Total program cost	\$927,077	\$1,171,802	\$835,190	\$1,263,689
<b>Direct cost per test</b>	\$40	\$101	\$29	\$115
<b>cost per diagnosed case</b>				
Direct cost	\$32,746	\$773	\$23,558	\$877
Operational cost	\$61,532	\$1,042	\$52,343	\$1,147
Total program cost	\$92,708	\$1,335	\$83,519	\$1,439
<b>cost per treatment initiated</b>				
Direct cost	\$40,933	\$1,726	\$29,447	\$1,960
Operational cost	\$76,915	\$2,329	\$65,429	\$2,563
Total program cost	\$115,885	\$2,982	\$104,399	\$3,215

## a Who tested more than once in the pilot?

See Supplementary Analyses, [Table 14](#)

People were considered having tested more than once if they have tested more than once within a year, with first test prior to 31 December 2019.

Testing more than once reflects ongoing use of the NSW DBS Pilot.

- 10% from the assisted registration pathway tested more than once
- 19% from the online self-registration pathway tested more than once

The proportion of people returning for testing was higher in young people, people outside of major cities and men who have sex with men.

- 16% of people aged <25 tested more than once
- 16% of people living outside major cities tested more than once
- 20% of men who have sex with men tested more than once

## b How many sites are still participating?

36 sites have approval and completed the required training to participate in the NSW DBS Pilot. 80% (29/36) performed testing in the last six months of this evaluation, indicating they are active in recruiting participants to the NSW DBS Pilot.

## c Number of sites which will participate

At the end of 2020, there were an additional 11 sites in the process of being approved to participate in the NSW DBS Pilot:

- Central Coast HARP/DACS
- HNE DACS (Southern)
- Northern Sydney Primary and Community Health
- NSLHD Brookvale Community Health
- Western NSW Mental Health & Drug and Alcohol Service
- Junee Correctional Centre
- Clarence Correctional Centre
- Matthew Talbot Hostel
- NSW Users and AIDS Association
- Hepatitis NSW
- Pharmaceutical Society of NSW

#### d What aspects of the pilot were modified during implementation?

Aspects of the NSW DBS Pilot were modified over time to facilitate maintenance:

- For assisted registration, sites operating in places without Wi-Fi could complete a paper-based form for participants and enter it online later. The paper-based form was adapted during implementation to make it user friendly
- For online self-registration, the webpage was optimized to improve user experience and reduce errors with data collection
- Testing kit packaging was changed to increase efficiency and reduce cost e.g. some prepared without cardboard cover for sites

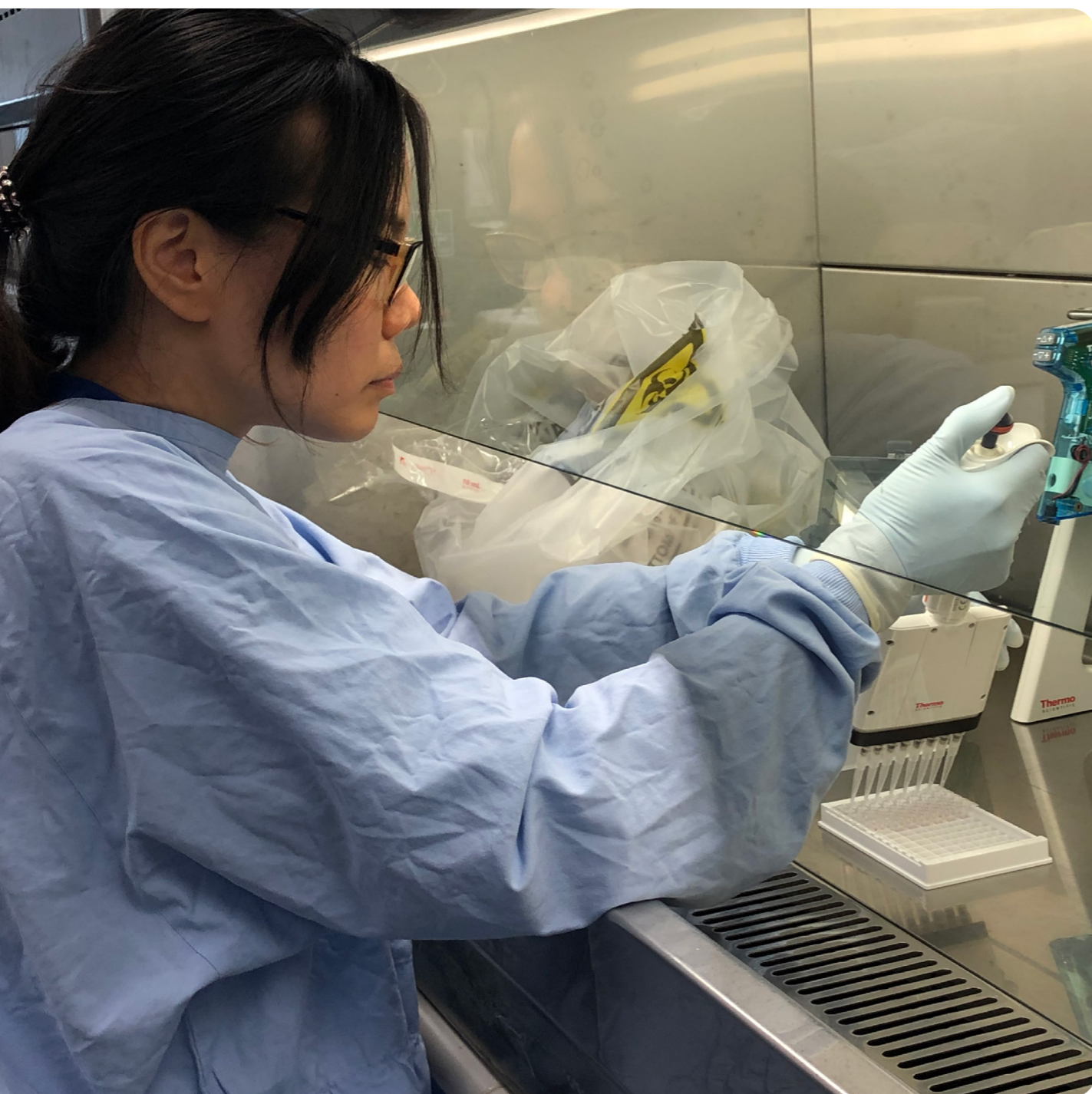

## CONCLUSION

- The NSW DBS Pilot improved the reach of HIV and hepatitis C testing for a range of priority populations and people who had not recently received testing
- Overall, ten new HIV diagnoses were detected: nine via online self-registration and one via assisted registration in prison. No new HIV diagnoses were detected via assisted registration in community settings
- There was low uptake of hepatitis C DBS testing via the online self-registration pathway, but the proportion of people with current hepatitis C infection among people who recently injected drugs was comparable to other settings
- Prison settings accounted for a high proportion of hepatitis C DBS tests in the NSW DBS Pilot and reported high treatment uptake
- Treatment uptake for hepatitis C testing in the community is lower than in prison but comparable with standard of care and demonstrates success in expanding the reach of testing for priority populations
- There are disparities in hepatitis C treatment uptake across settings
- The average cost per HIV treatment initiation following new diagnosis in the online self-registration pathway was \$35,417
- The average cost per HIV treatment initiation following new diagnosis in prison was \$213,975
- The average cost per hepatitis C treatment initiation in the online self-registration pathway was \$28,746
- The average cost per hepatitis C treatment initiation in the assisted registration pathway in the community was \$2,845
- The average cost per hepatitis C treatment initiation in the assisted registration pathway in prison was \$1,700

The results of this evaluation should be used to identify efficiencies and inform targeted testing for the remaining years of the NSW DBS Pilot.



## WHAT SHOULD BE IN PLACE TO SUSTAIN THE PILOT?

A number of operational and structural factors will mediate the sustainability of the current model of DBS testing.

### OPERATIONAL

- Communication of results – NSW Sexual Health Infolink played a pivotal role in delivering results to people diagnosed via online self-registration, but also assisted registration when sites were unable to do so. NSW Sexual Health Infolink also provided remote troubleshooting for people being tested and for staff at sites
- Clear and simplified pathways to care – the evaluation identified disparities in treatment uptake between different registration pathways. Sites with high proportions of treatment initiation can share their learnings with other sites to reduce gaps in the care cascade
- Supporting people through diagnosis and treatment – peer support was available at some sites to facilitate engagement in testing and treatment uptake
- Laboratory costs – ongoing costs borne by the laboratory included pathology, kit contents and preparation, postage of kits, distribution and maintenance of a results database

### STRUCTURAL

- Therapeutic Goods Administration (TGA) approvals – in order for testing to be performed outside of the research pilot, and further reduce barriers to testing, the use of DBS as a sample type for HIV and HCV RNA testing must be approved by TGA. The results from this report should encourage manufacturers apply to the TGA to approve the use of alternative sample types such as DBS with their assays
- A health economics justification– results presented in the report show variation in reach and effectiveness according to the registration pathway and setting. The subsequent section presents the total program costing for the NSW DBS Pilot. This will inform an ongoing cost-effectiveness and budget impact analysis for hepatitis C testing which will compare the NSW DBS Pilot components to standard of care

## IMPLICATIONS FOR PRACTICE

- Hepatitis C DBS testing in prison could be scaled up with additional resources to support more frequent testing “blitzes” and expand to private prisons
- DBS testing for hepatitis C via assisted registration in prisons and community settings should continue to be offered
- DBS testing for HIV infection via the online self-registration pathway should continue to be offered to priority populations at increased risk of HIV infection given its ability to reach significant numbers of people who have not tested recently
- DBS testing for hepatitis C infection via the online self-registration pathway shows promise and the low uptake so far in the pilot could be improved with promotional strategies to reach people who inject drugs who may not access other services
- Where DBS testing is offered in community or prison settings, consider only including HIV testing if specific HIV risk factors are identified
- The success in reaching priority populations in the community settings could be enhanced by ongoing promotion of the NSW DBS Pilot through targeted health promotion activities and communication strategies tailored to specific populations
- In-depth interviews with providers could provide important insights into barriers and facilitators to enhance DBS testing

# REFERENCES

1. Feld JJ, Jacobson IM, Hézode C, Asselah T, Ruane PJ, Gruener N, et al. Sofosbuvir and Velpatasvir for HCV Genotype 1, 2, 4, 5, and 6 Infection. *New England Journal of Medicine*. 2015 Dec 31;373(27):2599–607.
2. Marcus JL, Leyden WA, Alexeeff SE, Anderson AN, Hechter RC, Hu H, et al. Comparison of Overall and Comorbidity-Free Life Expectancy Between Insured Adults With and Without HIV Infection, 2000–2016. *JAMA Netw Open*. 2020 Jun 1;3(6):e207954.
3. Treloar C, Rance J, Backmund M. Understanding Barriers to Hepatitis C Virus Care and Stigmatization From a Social Perspective. *Clinical Infectious Diseases*. 2013;57(Suppl 2):51–5.
4. Golub SA, Gamarel KE. The impact of anticipated HIV stigma on delays in HIV testing behaviors: Findings from a community-based sample of men who have sex with men and transgender women in New York City. *AIDS Patient Care STDS*. 2013 Nov 1;27(11):621–7.
5. Cunningham E, Wheeler A, Hajarizadeh B, French C, Roche R, Marshall A, et al. Interventions to enhance testing and linkage to treatment for hepatitis C infection: a systematic review and meta-analysis. *Lancet Gastroenterol Hepatol*. 2021;
6. NSW Ministry of Health. NSW HIV Strategy 2021–2025 [Internet]. Sydney; 2020. Available from: [www.health.nsw.gov.au](http://www.health.nsw.gov.au)
7. NSW Ministry of Health. NSW Hepatitis C Strategy 2022–2025 [Internet]. Sydney; 2022. Available from: [www.health.nsw.gov.au](http://www.health.nsw.gov.au)
8. Catlett, B., Hajarizadeh, B., Cunningham, E., Wolfson-Stofko, B., Wheeler, A., Khandaker-Hussain, B., ... & Grebely, J. (2022). Diagnostic Accuracy of Assays Using Point-of-Care Testing or Dried Blood Spot Samples for the Determination of Hepatitis C Virus RNA: A Systematic Review. *The Journal of Infectious Diseases*, 226(6), 1005–1021.2
9. Catlett, B., Carrera, A., Starr, M., Applegate, T. L., Lowe, P., Grebely, J., & Cunningham, H. P. (2019). Performance evaluation of the Hologic Aptima HCV Quant Dx assay for detection of HCV RNA from dried blood spots. *Journal of Clinical Virology*, 112, 40–443
10. Catlett, B., Bajis, S., Starr, M., Dore, G. J., Hajarizadeh, B., Cunningham, P. H., ... & Grebely, J. (2021). Evaluation of the Aptima HCV Quant Dx Assay for Hepatitis C Virus RNA Detection from Fingerstick Capillary Dried Blood Spot and Venepuncture-Collected Samples. *The Journal of Infectious Diseases*, 223(5), 818–826.
11. Glasgow RE, Vogt TM, Boles SM. Evaluating the Public Health Impact of Health Promotion Interventions : The RE-AIM Framework. *Am J Public Health*. 1999;89(9).
12. Callander D, Mooney-Somers J, Keen P, Guy R, Duck T, Bavinton B, et al. Australian gay and lesbian postcodes (IJGIS) dataset. 2019;
13. NSW Ministry of Health. NSW HIV Strategy 2021–2025 - Quarter 4 & Annual Data Report 2021 [Internet]. Sydney; 2021 [cited 2022 Jul 6]. Available from: <https://www.health.nsw.gov.au/endinghiv/Publications/q4-2021-and-annual-hiv-data-report.pdf>
14. Public Health England. National HIV Self-Sampling Service. Two year service report: November 2015 to October 2017. 2018;(October):0–31.
15. NSW Ministry of Health. NSW HIV Strategy 2016 – 2020: Quarter 4 & Annual 2019 Data Report. 2019; Available from: <http://www.health.nsw.gov.au/endinghiv/Pages/tools-and-data.aspx>
16. Iversen J, Grebely J, Catlett B, Cunningham P, Dore GJ, Maher L. Estimating the cascade of hepatitis C testing, care and treatment among people who inject drugs in Australia. *International Journal of Drug Policy*. 2017;47(March 2016):77–85.
17. Valerio H, Alavi M, Conway A, Silk D, Treloar C, Martinello M, et al. Declining Prevalence of Current HCV Infection and Increased Treatment Uptake Among People Who Inject Drugs: The ETHOS Engage Study. *International Journal of Drug Policy*. 2022;

# ANNEX 1

## OUTCOME DEFINITIONS

### Sample returned

Completed registration and date of DBS card received in lab is recorded.

Source online registration:

<https://www.dbstest.health.nsw.gov.au/>

Source DBS card received in lab: Lab data

### Tested for HIV in last 2 years

A binary variable "Tested for HIV in last 2 years" Yes/No was constructed from the question "Last time you were tested for HIV?".

Source: <https://www.dbstest.health.nsw.gov.au/>

### Tested for hepatitis C in last 2 years

In September 2019, the question "Last time you were tested for hepatitis C?" was introduced. A binary variable "Tested for hepatitis C in last 2 years" Yes/No was constructed from this.

Source: <https://www.dbstest.health.nsw.gov.au/>

### Repeat testers

Individual identifier constructed for tests performed: first two letters of first name, first two letters of second name, date of birth.

Source identifier:

<https://www.dbstest.health.nsw.gov.au/>

Source test performed: Lab data

### HIV Test positivity

Positive test result recorded. People already diagnosed with HIV excluded from analysis.

Source: Lab data.

### Hepatitis C Test positivity

Positive test result recorded.

Source: Lab data.

### Confirmatory test performed

Treatment initiation is defined as HIV/hepatitis C confirmatory test performed in the 6 months following registration.

Source for online registration/ assisted when sites not responsible for follow-up: NSW Sexual Health Infoclink database.

Source for assisted registration: Site follow-up spreadsheet.

### Treatment initiated

Treatment initiation is defined as HIV/hepatitis C treatment prescribed in the 6 months following registration. For participants who did not initiate treatment, sites will select reason why from a number of options.

Source for online registration: NSW Sexual Health Infoclink database.

Source for assisted registration: Site follow-up spreadsheet.

### Acceptability

The acceptability survey was launched in June 2017 was administered via Survey Monkey and participants are prompted to complete the survey through text message reminders within 1 month of receiving a result from a DBS test. Questions focus on testing acceptability, ease of use overall and for various steps of self-collection, and their preferences for accessing and using DBS HIV/ hepatitis C self-collection in the future. Source for online registration: SurveyMonkey responses.

# ANNEX 2

## GENERAL CONSIDERATIONS FOR DATA ANALYSES

### STATISTICAL METHODS

Analysis results were presented using descriptive statistics. For categorical variables, the number (n) and percentage of participants in each category are presented. For continuous variables, the number of participants (n), mean and standard deviation (SD), median, interquartile range (IQR, Q1-Q3), range (minimum, maximum) were reported.

Statistical tests will be 2-sided and performed at the 5% significance level unless specified. All P values are reported to three decimal places. P values smaller than 0.001 are reported as P<0.001.

For the analysis of categorical outcomes Chi-squared tests or exact equivalents (for small numbers) were used.

### DATA HANDLING CONVENTIONS

#### Registration type

For the analyses of registration type, the <https://www.dbstest.health.nsw.gov.au/> registration database was used. Two variables "Do you require a DBS testing kit?" and "Is somebody helping to collect the sample?" were used to identify registration types:

	Do you require a DBS testing kit?	Is somebody helping to collect the sample?
Online registration	Yes	No
Assisted registration	No	Yes/No

Variation: The question "Is somebody helping to collect the sample" was introduced in 2019, so for cases pre-2019 the Kit Code was used to identify kits that had been distributed for off-site distribution.

#### Gender

The variable gender was recoded to align with the most recent version of the survey.

	Gender		
	Man	Woman	Other
Pre 2019	Male, transgender man	Female, transgender woman	
2019 onwards	Male	Female	Non-binary, gender fluid, different identity, prefer not to answer

## Transgender

The variable transgender was recoded to align with the most recent version of the survey.

	Transgender	
	Yes	No
Pre 2019	Transgender man, transgender woman	
2019 onwards	Was this the gender you were assigned at birth? (No)	Was this the gender you were assigned at birth? (Yes)

## Aboriginal and/or Torres Strait Islander

Five categories were recoded into a binary variable "Aboriginal and/or Torres Strait Islander"

Yes (Aboriginal, Torres Strait Islander, Both Aboriginal and Torres Strait Islander).

No (Neither Aboriginal or Torres Strait Islander, Prefer not to say).

## Major city postcode

The postcode provided at registration was used to code registrations according to the Accessibility and Remoteness Index of Australia (ARIA+) and categorised into Major Cities of Australia or other (Including Inner regional Australia, Outer Regional Australia, Remote Australia, Very Remote Australia).

## Men who have sex with men

A binary variable was created based on the answer male for both variables "Gender" and "When you have sex, who do you have sex with?"

In 2019, the survey changed the responses to the question "When you have sex, who do you have sex with?". Answers were recoded as below.

	When you have sex, who do you have sex with?	
	Men	Women
Pre 2019	Men only, men and women	Women only/ men and women
2019 onwards	Men, trans men	Women, trans women

## Sexual partner from Asia or Africa

A binary variable was created based on the responses to "Where have your sexual partner(s) been from (since your last HIV test or ever if you have never had a HIV test)?" In 2019, the survey changed the responses to this question from a multichoice response to multiple variables.

	Sexual partner from Asia or Africa	
	Yes	No
Pre 2019	Any combination of responses which includes Asia and/or Africa	
2019 onwards	Asia, Africa	

## Born outside of Australia

The variable "Country of birth" was recoded into "Born outside of Australia" with three categories: No (Born in Australia), Yes (Born in Asia or Africa), Yes (Born in other country).

## Speaks English at home

The variable "Language spoken at home" was recoded into a binary variable "Speaks English at home": No (Speaks language other than English), Yes (Speaks English at home).

## Recently injected drugs

In 2019, the survey changed the responses to the question about injecting drug use changing the time period from "In last 12 months" to "In last month". This is reported as "Recent injecting drug use".

	Recent injecting drug use	
	Yes	No
Pre 2019	In last 12 months	More than 12 months ago/never
2019 onwards	In last month	More than one month ago, never

## Assisted registration site code

The site of assisted registration was defined according to the <https://www.dbstest.health.nsw.gov.au/> registration database.

*Variation:* If missing, the site code was replaced with the site code provided in the lab database.

## Been to prison

Removed because it was introduced Sept 2019. The variable "Been to prison" was first collected in September 2019. Post-September 2019, anybody answering Yes to "Ever been in prison?" or who registered via Justice Health was coded as "Yes".





# ANNEX 3

## SUPPLEMENTARY ANALYSES

### ASSISTED DBS TESTS PERFORMED IN ASSISTED REGISTRATION, BY LOCAL HEALTH DISTRICT (excluding Justice Health)

- Testing for people registered via assisted registration was carried out in 12 Local Health Districts (LHDs) and St Vincent's Health Network.
- 78% of tests for people registered via assisted registration were carried out in five LHDs: South Eastern Sydney, South Western Sydney, Illawarra Shoalhaven, Nepean Blue Mountains and Sydney.
- South Eastern Sydney consistently performed a high number of tests since the introduction of the assisted registration pathway in 2018, 84% of those were performed at Kirketon Road Centre sites.

**Figure 19: Number of tests performed per quarter in assisted registration pathway by site Local Health District (LHD), NSW DBS Pilot November 2016-December 2020**

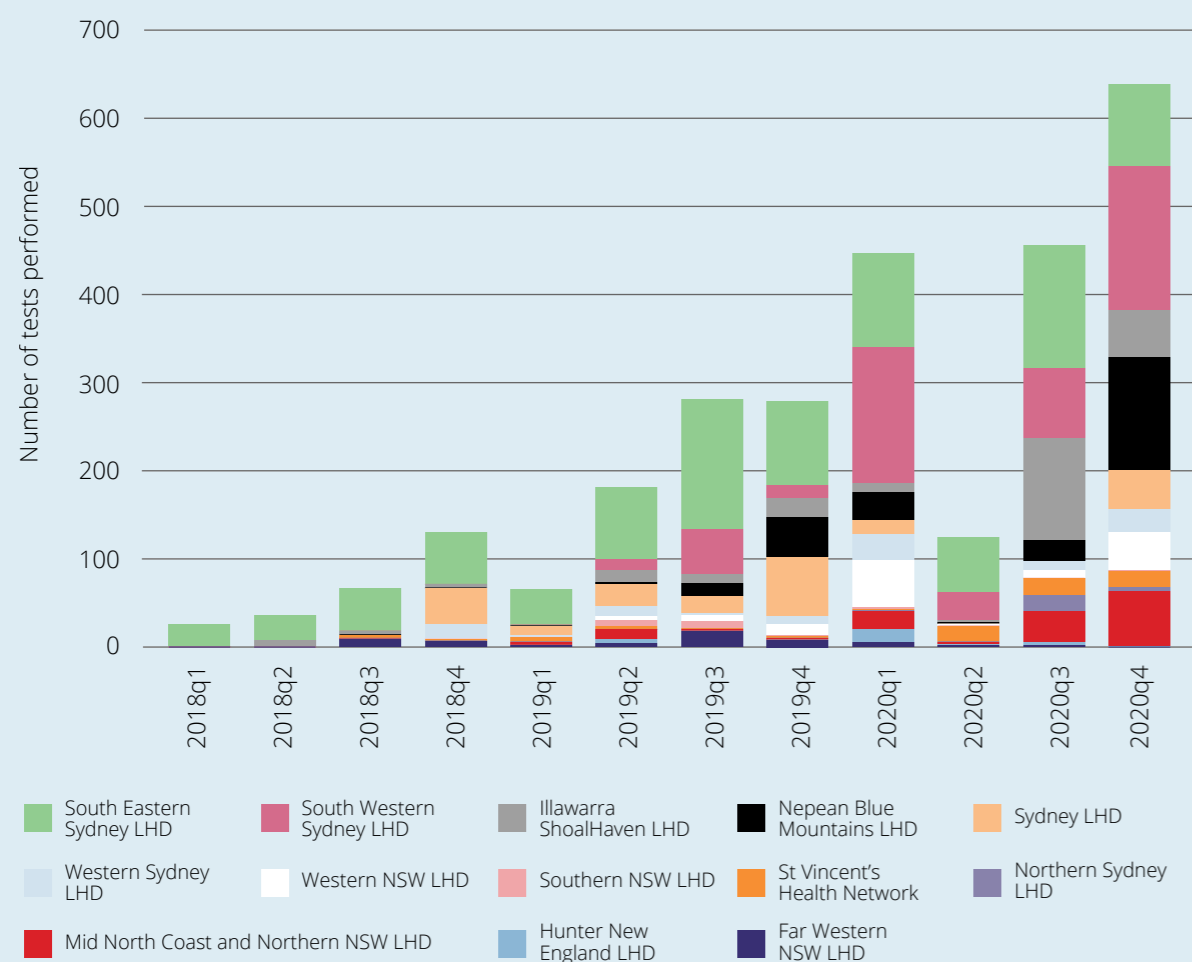

### DBS TESTS PERFORMED BY LHD

**Table 9: Tests performed per year by site LHD (excluding Justice Health), NSW DBS Pilot November 2016-December 2020**

	Total		2018		2019		2020	
	N	% col	N	% col	N	% col	N	% col
South Eastern Sydney LHD	927	34%	162	63%	365	45%	400	24%
South Western Sydney LHD	504	18%	0	0%	77	9%	427	25%
Nepean Blue Mountains LHD	248	9%	0	0%	62	8%	186	11%
Illawarra Shoalhaven LHD	245	9%	15	6%	47	6%	183	11%
Sydney LHD	224	8%	42	16%	122	15%	60	4%
Mid North Coast and Northern NSW LHD	143	5%	2	1%	19	2%	122	7%
Western NSW LHD	132	5%	0	0%	24	3%	108	6%
Western Sydney LHD	107	4%	17	7%	25	3%	65	4%
St Vincent's Health Network	75	3%	5	2%	13	2%	57	3%
Far Western NSW LHD	56	2%	15	6%	32	4%	9	1%
Hunter New England LHD	25	1%	0	0%	5	1%	20	1%
Northern Sydney LHD	23	1%	0	0%	0	0%	23	1%
Southern NSW LHD	18	1%	0	0%	15	2%	3	0%
<b>Total</b>	<b>2757</b>		<b>258</b>		<b>816</b>		<b>1,683</b>	

**Table 10: Characteristics of people tested by registration type, NSW DBS Pilot November 2016-December 2020**

Variables	People tested		Online self-registration		Assisted registration	
	N	% col	N	% col	N	% col
<b>Total</b>	<b>7392</b>		<b>1559</b>		<b>5833</b>	
Test performed						
HIV + hepatitis C	5467	74%	269	17%	5198	89%
HIV only	1441	19%	1282	82%	159	3%
Hepatitis C only	484	7%	8	1%	476	8%
Gender						
Men	5752	78%	1340	86%	4412	76%
Women	1573	21%	205	13%	1368	23%
Non-binary/ other	67	1%	14	1%	53	1%
Age						
=<25	1194	16%	490	31%	704	12%
25-34	2308	31%	607	39%	1701	29%
35-44	1981	27%	243	16%	1738	30%
45-54	1279	17%	120	8%	1159	20%
>55	630	9%	99	6%	531	9%
Aboriginal and/or Torres Strait Islander						
No	5255	71%	1499	96%	3756	64%
Yes	2137	29%	60	4%	2077	36%
Major city postcode						
No	901	12%	354	23%	547	9%
Yes	6491	88%	1205	77%	5286	91%
Men who have sex with men						
No	6054	82%	548	35%	5506	94%
Yes	1338	18%	1011	65%	327	6%
Sexual partner from Asia or Africa						
No	6171	83%	981	63%	5190	89%
Yes	1221	17%	578	37%	643	11%
Born outside of Australia						
No	5896	80%	845	54%	5051	87%
Yes, Asia or Africa	757	10%	489	31%	268	5%
Yes, other	739	10%	225	14%	514	9%
Speaks English at home						
No	813	11%	418	27%	395	7%
Yes	6579	89%	1141	73%	5438	93%
Recently injected drugs						
No	3780	51%	1436	92%	2344	40%
Yes	3360	45%	98	6%	3262	56%
Prefer not to say	250	3%	23	1%	227	4%
Assisted registration setting						
Community					2523	43%
Justice Health					3310	57%

**Table 11: Characteristics of online registrations by return of sample to lab, NSW DBS Pilot November 2016-December 2020**

Variables	Total online registrations		Did not return DBS sample to lab		Returned DBS sample to lab	
	N	% col	N	% row	N	% row
<b>Total</b>	<b>3506</b>		<b>1258</b>	<b>36%</b>	<b>2248</b>	<b>64%</b>
Test performed						
HIV + hepatitis C	653	19%	270	41%	383	59%
HIV only	2839	81%	985	35%	1854	65%
Hepatitis C only	14	0%	3	21%	11	79%
Gender						
Men	3045	87%	1052	35%	1993	65%
Women	409	12%	175	43%	234	57%
Non-binary/ other	52	1%	31	60%	21	40%
Age						
=<25	1076	31%	374	35%	702	65%
25-34	1364	39%	499	37%	865	63%
35-44	549	16%	230	42%	319	58%
45-54	285	8%	103	36%	182	64%
>55	232	7%	52	22%	180	78%
Aboriginal and/or Torres Strait Islander						
No	3350	96%	1172	35%	2178	65%
Yes	156	4%	86	55%	70	45%
Major city postcode						
No	843	24%	292	35%	551	65%
Yes	2663	76%	966	36%	1697	64%
Men who have sex with men						
No	1068	30%	426	40%	642	60%
Yes	2438	70%	832	34%	1606	66%
Sexual partner from Asia or Africa						
No	2337	67%	848	36%	1489	64%
Yes	1169	33%	410	35%	759	65%
Born outside of Australia						
No	2035	58%	746	37%	1289	63%
Yes, Asia or Africa	991	28%	355	36%	636	64%
Yes, other	480	14%	157	33%	323	67%
Speaks English at home						
No	854	24%	305	36%	549	64%
Yes	2652	76%	953	36%	1699	64%
Recently injected drugs						
No	3202	91%	1118	35%	2084	65%
Yes	239	7%	110	46%	129	54%
Prefer not to say	59	2%	26	44%	33	56%

**Table 12: Characteristics of people not recently tested for HIV by registration type, NSW DBS Pilot November 2016-December 2020**

Variables	Overall			Online			Assisted		
	Total people tested for HIV	Tested more than 2 years ago or never		Total people tested for HIV	Tested more than 2 years ago or never		Total people tested for HIV	Tested more than 2 years ago or never	
	N	N	%	N	N	%	N	N	%
<b>Total</b>	<b>6922</b>	<b>3521</b>	<b>51%</b>	<b>1551</b>	<b>931</b>	<b>60%</b>	<b>5371</b>	<b>2590</b>	<b>48%</b>
Test performed									
HIV + hepatitis C	5481	2676	49%	269	181	67%	5212	2495	48%
HIV only	1441	845	59%	1282	750	59%	159	95	60%
Hepatitis C only	484	8	1%	476					
Gender									
Men	5365	2724	51%	1337	777	58%	4028	1947	48%
Women	1491	767	51%	200	147	74%	1291	620	48%
Non-binary/ other	66	30	45%	14	7	50%	52	23	44%
Age									
=<25	1138	662	58%	489	334	68%	649	328	51%
25-34	2158	1016	47%	606	333	55%	1552	683	44%
35-44	1851	833	45%	240	134	56%	1611	699	43%
45-54	1195	629	53%	118	68	58%	1077	561	52%
>55	580	381	66%	98	62	63%	482	319	66%
Aboriginal and/or Torres Strait Islander									
No	4953	2650	54%	1494	894	60%	3459	1756	51%
Yes	1969	871	44%	57	37	65%	1912	834	44%
Major city postcode									
No	876	519	59%	351	208	59%	525	311	59%
Yes	6046	3002	50%	1200	723	60%	4846	2279	47%
Men who have sex with men									
No	5599	2859	51%	540	397	74%	5059	2462	49%
Yes	1323	662	50%	1011	534	53%	312	128	41%
Sexual partner from Asia or Africa									
No	5729	2810	49%	975	543	56%	4754	2267	48%
Yes	1193	711	60%	576	388	67%	617	323	52%
Born outside of Australia									
No	5482	2658	48%	839	497	59%	4643	2161	47%
Yes, Asia or Africa	741	468	63%	487	314	64%	254	154	61%
Yes, other	699	395	57%	225	120	53%	474	275	58%
Speaks English at home									
No	788	485	62%	417	266	64%	371	219	59%
Yes	6134	3036	49%	1134	665	59%	5000	2371	47%

Variables	Overall			Online			Assisted		
	Total people tested for HIV	Tested more than 2 years ago or never		Total people tested for HIV	Tested more than 2 years ago or never		Total people tested for HIV	Tested more than 2 years ago or never	
	N	N	%	N	N	%	N	N	%
Recently injected drugs									
No	3477	2027	58%	1431	857	60%	2046	1170	57%
Yes	3203	1338	42%	95	60	63%	3108	1278	41%
Prefer not to say	240	155	65%	23	13	57%	217	142	65%
Assisted registration setting									
Community							2401	1264	53%
Justice Health							2970	1326	45%

**Table 13: Characteristics of people not recently tested for hepatitis C by registration type, NSW DBS Pilot September 2019-December 2020\***

Variables	Overall			Online			Assisted		
	Total people tested for hepatitis C in pilot	Tested more than 2 years ago or never		Total people tested for hepatitis C in pilot	Tested more than 2 years ago or never		Total people tested for hepatitis C in pilot	Tested more than 2 years ago or never	
	N	N	%	N	N	%	N	N	%
<b>Total</b>	<b>4112</b>	<b>1851</b>	<b>45%</b>	<b>240</b>	<b>177</b>	<b>74%</b>	<b>3872</b>	<b>1674</b>	<b>43%</b>
Test performed									
HIV + hepatitis C	3581	1675	47%	230	169	73%	3351	1506	45%
Hepatitis C only	531	176	33%	10	8	80%	521	168	32%
Gender									
Men	3150	1433	45%	195	137	70%	2955	1296	44%
Women	918	394	43%	41	36	88%	877	358	41%
Non-binary/ other	44	24	55%	4	4	100%	40	20	50%
Age									
=<25	495	245	49%	72	58	81%	423	187	44%
25-34	1192	500	42%	96	71	74%	1096	429	39%
35-44	1212	466	38%	43	25	58%	1169	441	38%
45-54	806	400	50%	16	13	81%	790	387	49%
>55	407	240	59%	13	10	77%	394	230	58%
Aboriginal and/or Torres Strait Islander									
No	2755	1333	48%	213	156	73%	2542	1177	46%
Yes	1357	518	38%	27	21	78%	1330	497	37%
Major city postcode									
No	480	231	48%	47	28	60%	433	203	47%
Yes	3632	1620	45%	193	149	77%	3439	1471	43%

\*Question on hepatitis C testing history was added to the survey in September 2019

Variables	Overall			Online			Assisted		
	Total people tested for hepatitis C in pilot	Tested more than 2 years ago or never		Total people tested for hepatitis C in pilot	Tested more than 2 years ago or never		Total people tested for hepatitis C in pilot	Tested more than 2 years ago or never	
	N	N	%	N	N	%	N	N	%
Men who have sex with men									
No	3824	1701	44%	109	89	82%	3715	1612	43%
Yes	288	150	52%	131	88	67%	157	62	39%
Born outside of Australia									
No	3430	1439	42%	104	71	68%	3326	1368	41%
Yes, Asia or Africa	284	185	65%	105	83	79%	179	102	57%
Yes, other	398	227	57%	31	23	74%	367	204	56%
Speaks English at home									
No	337	210	62%	64	50	78%	273	160	59%
Yes	3775	1641	43%	176	127	72%	3599	1514	42%
Recently injected drugs									
No	2406	1233	51%	213	157	74%	2193	1076	49%
Yes	1481	474	32%	17	11	65%	1464	463	32%
Prefer not to say	225	144	64%	10	9	90%	215	135	63%
Assisted registration setting									
Community							1815	798	44%
Justice Health							2057	876	43%

**Table 14: Characteristics of people tested more than once in DBS Pilot, NSW DBS Pilot November 2016-December 2020**

Variables	Total people tested – first enrolment pre-2020		Single visit		Repeat tester	
	N	% col	N	% row	N	% row
<b>Total</b>	<b>4268</b>		<b>3735</b>	<b>88%</b>	<b>533</b>	<b>12%</b>
Registration type						
Online self-registration	1202	28%	971	81%	231	19%
Assisted registration	3066	72%	2764	90%	302	10%
Test performed						
HIV + hepatitis C	2944	69%	2647	90%	297	10%
HIV only	1239	29%	1008	81%	231	19%
hepatitis C only	85	2%	80	94%	5	6%
Gender						
Men	3279	77%	2853	87%	426	13%
Women	951	22%	849	89%	102	11%
Non-binary/ other	38	1%	33	87%	5	13%
Age						
=<25	781	18%	658	84%	123	16%
25-34	1415	33%	1238	87%	177	13%
35-44	1093	26%	975	89%	118	11%
45-54	679	16%	598	88%	81	12%
>55	300	7%	266	89%	34	11%
Aboriginal and/or Torres Strait Islander						
No	3101	73%	2695	87%	406	13%
Yes	1167	27%	1040	89%	127	11%
Major city postcode						
No	466	11%	393	84%	73	16%
Yes	3802	89%	3342	88%	460	12%
Men who have sex with men						
No	3210	75%	2889	90%	321	10%
Yes	1058	25%	846	80%	212	20%
Sexual partner from Asia or Africa						
No	3389	79%	2958	87%	431	13%
Yes	879	21%	777	88%	102	12%
Born outside of Australia						
No	3381	79%	2958	87%	423	13%
Yes, Asia or Africa	481	11%	419	87%	62	13%
Yes, other	406	10%	358	88%	48	12%
Speaks English at home						
No	517	12%	445	86%	72	14%
Yes	3751	88%	3290	88%	461	12%
Recently injected drugs						
No	1919	45%	1658	86%	261	14%
Yes	2306	54%	2039	88%	267	12%
Prefer not to say	41	1%	36	88%	5	12%

**Table 15: Characteristics of people newly diagnosed with HIV and treatment initiation within six months, NSW DBS Pilot November 2016-December 2020**

Variables	Total people tested for HIV		New diagnosis		Initiated treatment within 6 months	
	N	%	N	% of people tested	N	% of new diagnoses
<b>Total</b>	<b>6922</b>		<b>10</b>	<b>0.1%</b>	<b>8</b>	<b>80%</b>
Registration type						
Online	1551	22%	9	0.6%	7	78%
Assisted (community)	2401	35%	0	-	0	-
Assisted (prison)	2970	43%	1	0.0%	1	100%
Test performed						
HIV + hepatitis C	5481	79%	3	0.1%	3	100%
Hepatitis C only	1441	21%	7	0.5%	5	71%
Gender, n (%)						
Men	5365	78%	10	0.2%	8	80%
Women	1491	22%	0	-	0	-
Non-binary/ other	66	1%	0	-	0	-
Age						
=<25	1138	16%	2	0.2%	1	50%
25-34	2158	31%	6	0.3%	5	83%
35-44	1851	27%	2	0.1%	2	100%
45-54	1195	17%	0	-	0	-
>55	580	8%	0	-	0	-
Aboriginal and/or Torres Strait Islander						
No	4953	72%	8	0.2%	6	75%
Yes	1969	28%	2	0.1%	2	100%
Major city postcode						
No	876	13%	3	0.3%	2	67%
Yes	6046	87%	7	0.1%	6	86%
Men who have sex with men						
No	5599	81%	1	0.0%	1	100%
Yes	1323	19%	9	0.7%	7	78%
Born outside of Australia						
No	5482	79%	5	0.1%	5	100%
Yes, Asia or Africa	741	11%	2	0.3%	1	50%
Yes, other	699	10%	3	0.4%	2	66%
Speaks English at home						
No	788	11%	2	0.3%	1	50%
Yes	6134	89%	8	0.1%	7	88%
Recently injected drugs						
No	3477	50%	9	0.3%	7	78%
Yes	3203	46%	1	0.0%	1	100%
Prefer not to say	240	3%	0	-	0	-

**Table 16: Characteristics of people with current hepatitis C infection, NSW DBS Pilot September 2017-December 2020**

Variables	Total people tested for hepatitis C		No current hepatitis C infection		Current hepatitis C infection		p value
	N	%col	n	%row	n	%row	
<b>Total</b>	<b>5960</b>		<b>5082</b>	<b>85%</b>	<b>878</b>	<b>15%</b>	
Registration type							
Online	328	6%	313	95%	15	5%	
Assisted (community)	2357	40%	1948	83%	409	17%	
Assisted (prison)	3275	55%	2821	86%	454	14%	<0.001
Test performed							
HIV + hepatitis C	5472	92%	4661	85%	811	15%	
Hepatitis C only	488	8%	421	86%	67	14%	0.515
Gender							
Men	4517	76%	3853	85%	664	15%	
Women	1390	23%	1188	85%	202	15%	
Non-binary/ other	53	1%	41	77%	12	23%	0.261
Age							
=<25	749	13%	639	85%	110	15%	
25-34	1768	30%	1555	88%	213	12%	
35-44	1755	29%	1471	84%	284	16%	
45-54	1162	19%	942	81%	220	19%	
>55	526	9%	475	90%	51	10%	<0.001
Aboriginal and/or Torres Strait Islander							
No	3857	65%	3328	86%	529	14%	
Yes	2103	35%	1754	83%	349	17%	0.003
Major city postcode							
No	593	10%	487	82%	106	18%	
Yes	5367	90%	4595	86%	772	14%	0.023
Men who have sex with men							
No	5526	93%	4682	85%	844	15%	
Yes	434	7%	400	92%	34	8%	<0.001
Born outside of Australia							
No	5084	85%	4271	84%	813	16%	
Yes, Asia or Africa	347	6%	331	95%	16	5%	
Yes, other	529	9%	480	91%	49	9%	<0.001
Speaks English at home							
No	439	7%	405	92%	34	8%	
Yes	5521	93%	4677	85%	844	15%	<0.001
Recently injected drugs							
No	2443	41%	2255	92%	188	8%	
Yes	3292	55%	2618	80%	674	20%	
Prefer not to say	225	4%	209	93%	16	7%	<0.001

**Table 17: People with current hepatitis C infection by registration type, NSW DBS Pilot September 2017-December 2020**

Variables	Total			Online self-registration			Assisted registration		
	Overall	hep C	%	Overall	hep C	%	Overall	hep C	%
<b>Total</b>	<b>5960</b>	<b>878</b>	<b>15%</b>	<b>328</b>	<b>15</b>	<b>5%</b>	<b>5632</b>	<b>863</b>	<b>15%</b>
Test performed									
HIV + hepatitis C	5472	811	15%	320	12	4%	5152	799	16%
Hepatitis C only	488	67	14%	8	3	38%	480	64	13%
Gender									
Men	4517	664	15%	266	12	5%	4251	652	15%
Women	1390	202	15%	58	3	5%	1332	199	15%
Non-binary/ other	53	12	23%	4	0	0%	49	12	24%
Age									
=<25	749	110	15%	84	0	0%	665	110	17%
25-34	1768	213	12%	126	2	2%	1642	211	13%
35-44	1755	284	16%	64	7	11%	1691	277	16%
45-54	1162	220	19%	33	5	15%	1129	215	19%
>55	526	51	10%	21	1	5%	505	50	10%
Aboriginal and/or Torres Strait Islander									
No	3857	529	14%	276	10	4%	3581	519	14%
Yes	2103	349	17%	52	5	10%	2051	344	17%
Major city postcode									
No	593	106	18%	86	6	7%	507	100	20%
Yes	5367	772	14%	242	9	4%	5125	763	15%
Men who have sex with men									
No	5526	844	15%	147	12	8%	5379	832	15%
Yes	434	34	8%	181	3	2%	253	31	12%
Born outside of Australia									
No	5084	813	16%	173	15	9%	4911	798	16%
Yes, Asia or Africa	347	16	5%	114	0	0%	233	16	7%
Yes, other	529	49	9%	41	0	0%	488	49	10%
Speaks English at home									
No	439	34	8%	72	0	0%	367	34	9%
Yes	5521	844	15%	256	15	6%	5265	829	16%
Recently injected drugs									
No	2443	188	8%	231	3	1%	2212	185	8%
Yes	3292	674	20%	86	12	14%	3206	662	21%
Prefer not to say	225	16	7%	11	0	0%	214	16	7%

**Table 18: Confirmatory testing among people with current hepatitis C infection, NSW DBS Pilot September 2017-December 2020**

Variables	Total people with current hepatitis C infection	Completed confirmatory test within 6 months		
		N	n	%
<b>Total</b>	<b>878</b>	<b>533</b>	<b>61%</b>	
Registration type				
Online	15	2	13%	
Assisted (community)	392	157	40%	
Assisted (prison)	471	374	79%	<0.001
Test performed				
HIV + hepatitis C	804	479	60%	
Hepatitis C only	74	54	73%	0.024
Gender				
Men	667	435	65%	
Women	200	93	47%	
Non-binary/ other	11	5	45%	<0.001
Age				
=<25	111	86	77%	
25-34	220	161	73%	
35-44	279	155	56%	
45-54	222	115	52%	
>55	46	16	35%	<0.001
Aboriginal and/or Torres Strait Islander				
No	530	312	59%	
Yes	348	221	64%	0.169
Major city postcode				
No	103	39	38%	
Yes	775	494	64%	<0.001
Men who have sex with men				
No	843	513	61%	
Yes	35	20	57%	0.660
Born outside of Australia				
No	812	494	61%	
Yes, Asia or Africa	16	8	50%	
Yes, other	50	31	62%	0.667
Speaks English at home				
No	36	23	64%	
Yes	842	510	61%	0.690
Recently injected drugs				
No	189	123	65%	
Yes	669	395	59%	
Prefer not to say	20	15	75%	0.135

**Table 19: Treatment initiation in people with current hepatitis C infection, NSW DBS Pilot September 2017-December 2020**

Variables	Total people with current hepatitis C infection	Initiated treatment within 6 months		
	N	n	% row	p value
<b>Total</b>	<b>878</b>	<b>393</b>	<b>45%</b>	
Registration type				
Online	15	2	13%	
Assisted (community)	392	106	27%	
Assisted (prison)	471	285	61%	<0.001
Test performed				
HIV + hepatitis C	804	355	44%	
Hepatitis C only	74	38	51%	0.233
Gender				
Men	667	325	49%	
Women	200	64	32%	
Non-binary/ other	11	4	36%	<0.001
Age				
≤25	111	68	61%	
25-34	220	112	51%	
35-44	279	114	41%	
45-54	222	89	40%	
>55	46	10	22%	<0.001
Aboriginal and/or Torres Strait Islander				
No	530	222	42%	
Yes	348	171	49%	0.035
Major city postcode				
No	103	32	31%	
Yes	775	361	47%	0.003
Men who have sex with men				
No	843	378	45%	
Yes	35	15	43%	0.817
Born outside of Australia				
No	812	363	45%	
Yes, Asia or Africa	16	7	44%	
Yes, other	50	23	46%	0.981
Speaks English at home				
No	36	18	50%	
Yes	842	375	45%	0.519
Recently injected drugs				
No	189	89	47%	
Yes	669	290	43%	
Prefer not to say	20	14	70%	0.047

# ANNEX 4

## HEALTH ECONOMICS ANALYSIS METHODOLOGY

Costs were estimated from the perspective of the provider/funder. Total and annual costs of the program were identified, measured, valued, and collated in linked Excel spreadsheets. Costs were compared to the testing outcome data in numbers of HIV and HCV diagnosis and treatment initiated to produce cost-outcome ratios.

The total costs associated with delivering the intervention (both online self-registration and assisted registration pathways) included online registration platform, staffing, delivery of DBS kits, laboratory testing, result communication, follow-up, HCV treatment assessment, other consumables and equipment, training, and program coordination. These costs were estimated taking an ingredients-based approach ascertained from participating sites supplemented with budget and financial information from the DBS pilot program. Pathway analysis was conducted using a time and motion data collection template designed specifically for this study to estimate testing staff time cost.

The fixed costs of the NSW DBS Pilot, such as the program coordination, training, IT facilities, marketing, and communications (translation of materials), were provided by the pilot program based on the financial records (Table 20). The fixed costs were proportioned to the online self-registration pathway and assisted registration pathway according to the proportion of tests performed in each pathway.

**Table 20: Fixed costs estimated based on the DBS pilot program and financial information**

Item	Amount	Comment
<b>DBS staffing and training</b>		
1.0 FTE DBS Coordinator + 0.1 FTE RN	\$151,070	annual
0.1 SHIL IT staff	\$33,051	annual
Travel and accommodation	\$3,000	annual
GCP training	\$550	DBS training provided by Coordinator
<b>IT costs</b>		
Computer (program coordinator)	\$1,813	
SHIL computing infrastructure	\$2,932	annual
SHIL software licences	\$10,986	annual
Website costs	\$7,570	annual
Data plan	\$432	annual
SSHC SHIL database SMS (results delivery)	\$600	annual
Webcode SMS global (confirmation texts)	\$600	annual
IT maintenance (0.1 FTE level 6 Senior Analyst)	\$13,220	annual
<b>Marketing</b>		
Marketing, advertising and printing	\$101,000	Total up to Dec 2020
<b>Translations</b>		
Translation of patient information	\$58,627	
<b>Total fixed costs</b>	<b>\$1,093,075</b>	

Variable costs of the DBS kit and laboratory testing were provided by the NSW State Reference Laboratory for HIV/AIDS at St Vincent's Hospital Sydney. The consumables included lancet, collection kit, postage, labour, reagents, consumables, and specimen storage Table 21. Shared costs of postage and pathology labour for combined HIV and HCV tests were distributed by two ways, i.e. equal distribution and marginal distribution. The numbers of test kits requested by registered individuals and the tests performed by the NSW State Reference Laboratory for HIV/AIDS are presented in Table 22. The unit costs in Table 21 were combined with the test numbers in Table 22 to generate the pathology costs.

**Table 21: Variable costs of the DBS test by pathway and test type**

Pathway	Tests	Kit consumables	Kit delivery	Kit return	HIV screen	HCV screen	Total
Online self-registration	HIV	\$6.80	\$8.52	\$2.26	\$11.28	-	<b>\$28.85</b>
Online self-registration	HIV + HCV	\$6.80	\$8.52	\$2.26	\$11.28	\$54.54	<b>\$83.39</b>
Online self-registration	HCV	\$6.80	\$8.52	\$2.26	-	\$54.54	<b>\$72.12</b>
Assisted registration	HIV	\$6.80	\$1.00	\$2.26	\$11.28	-	<b>\$21.33</b>
Assisted registration	HIV + HCV	\$6.80	\$1.00	\$2.26	\$11.28	\$54.54	<b>\$75.87</b>
Assisted registration	HCV	\$6.80	\$1.00	\$2.26	-	\$54.54	<b>\$64.60</b>

**Table 22: DBS test kits delivered to participants/sites and tests performed in the lab by settings**

Pathway	Tests	Tests requested	Tests sent to sites	Tests performed
Online self-registration	HIV	2824	-	1833
Online self-registration	HIV + HCV	649		376
Online self-registration	HCV	13		10
Assisted registration (Community)	HIV		8744	139
Assisted registration (Community)	HIV + HCV			2569
Assisted registration (Community)	HCV			155
Assisted registration (Prison)	HIV		5070	37
Assisted registration (Prison)	HIV + HCV			3180
Assisted registration (Prison)	HCV			404

Time and motion data were collected from the Mid North Coast Liver Clinics and one prison. The Liver Clinics recorded time in each task along the DBS testing pathway and the personnel performing the tasks for 20 DBS tests, 4 positives and 16 negatives. Hourly rates of each personnel type were based on the Public Health System Nurses' & Midwives' (State) Award 2021, NSW and Health Professional and Medical Salaries (State) Award 2021 NSW. The hourly rates and time spent for each DBS test were combined to estimate the testing staff time costs. Time of testing tasks and personnel were estimated by the Justice Health staff for one prison blitz testing session of 152 participants. This blitz testing involved one

registered nurse (RN5), one clinical nurse consultant, and correctional officers with hourly rates sourced from the public salary Award in NSW. The average time and average time cost for each DBS test in the community setting and prison are presented in Table 23.

The average times for one negative DBS test result were similar in the community and prison settings, 35 minutes (\$25) in the community and 39 minutes (\$33) in prison. However, the average time involved in one positive DBS test result was much higher in prison (3 hours, \$210) compared to (1.25 hours, \$57) in the community. Two factors, higher hourly rate (clinical nurse consultant) and longer time spent on positive cases, were associated with a higher time cost in prison. On the other hand, a clinical nurse consultant dedicating time and effort for people diagnosed with current HCV infection may play a role in the higher treatment uptake observed in the NSW DBS Pilot. Further personnel adjustments in providing administrative support might reduce the time cost for the prison testing.

**Table 23: Estimated testing staff time costs in the community and prison**

Pathway	Test outcome	Number	Average time (minutes)	Average cost
Assisted registration (Community)	Negative	16	35	\$25
	Positive	4	75	\$57
	All	20	43	\$31
Assisted registration (Prison)	Negative	132	39	\$33
	Positive	20*	179	\$210
	All	152	57	\$57

\*Number of positive cases estimated based on the overall prevalence of current HCV infection (13.4%).

Cost-outcome ratios (average cost per diagnosed case and average cost per treatment initiated) were generated by dividing costs by HIV and HCV cases presented in Table 24. HCV RNA was detected in 916 tests (878 unique people). There were a total of 52 people with HIV positive result, with 9 of those newly diagnosed. With similar detected case numbers, proportion of treatment initiation in prison (61%) was twice as high as in the community (27%).

**Table 24: Numbers of diagnosis and treatment initiation by pathway and settings**

Pathway	HCV diagnosis (all tests)	HCV diagnosis (unique people)	HCV treatment initiated (unique people)	HIV new diagnosis	HIV treatment initiated
Online self-registration	16	15	2	8	7
Assisted registration (Community)	429	392	106	0	0
Assisted registration (Prison)	471	471	285	1	1



